

JANUARY 1981

\$3.00

BME

BROADCAST MANAGEMENT ENGINEERING

THE ECONOMY



IRAN



KUDD0018986-XM-5801 A11
T M DENBRDQK CE
KUDW RADIO
325 CMU-U OF WASHINGTON
SEATTLE
-AD



UNEMPLOYMENT



TECHNOLOGY FOR BETTER JOURNALISM.

It makes our competitors nervous to discuss these standard ADM benefits

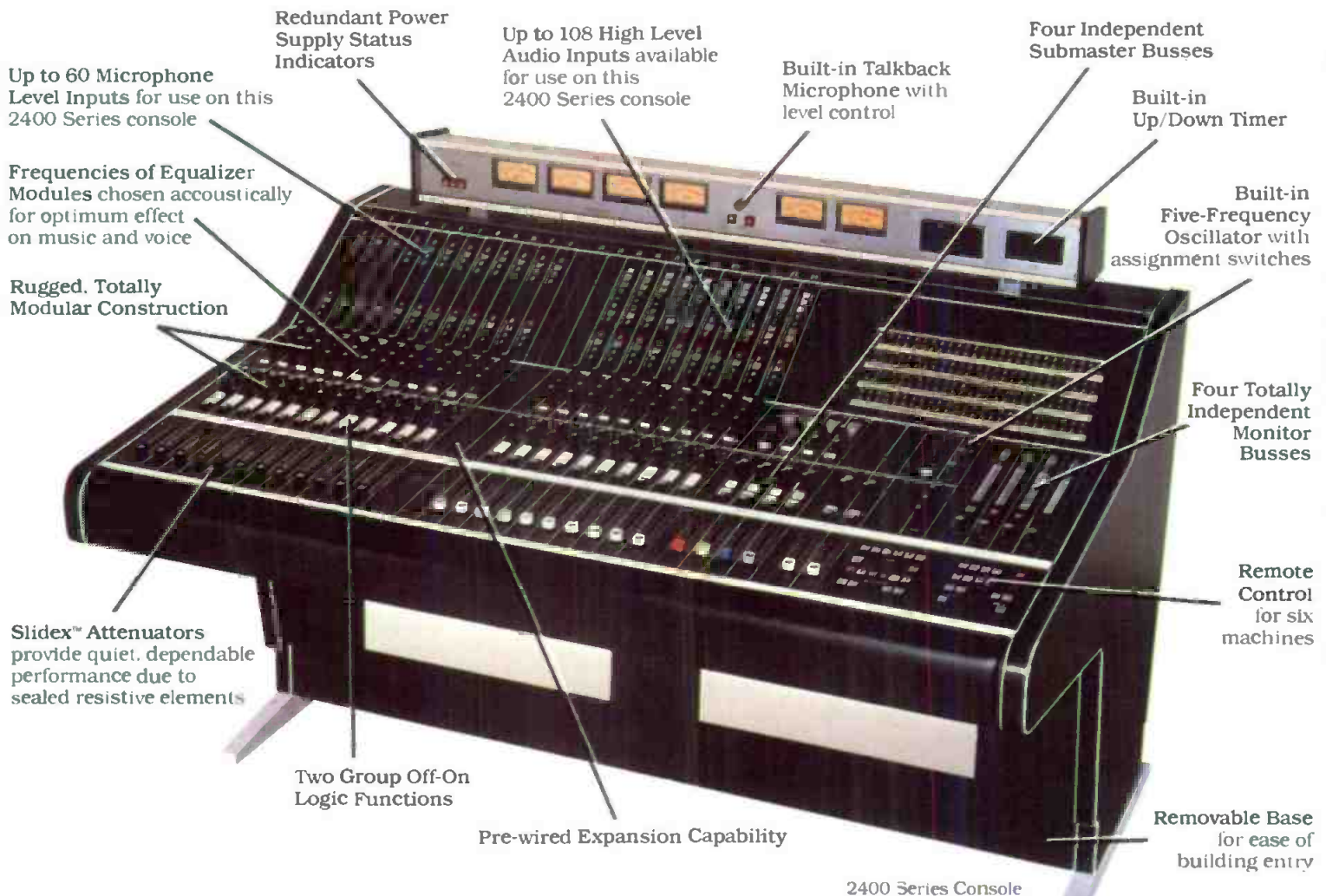

Talk to other console salesmen about any of these features and you'll get a lot of throat clearing and foot shuffling. Query our salesmen and you'll get a lot of facts about ADM features that help you do a better job and he'll tell you about our exclusive 5-year warranty. (Yes, we *have* to build them better, and we do!)

Learn more about our Series 3200, 2400, 1600 or 800 ADM Audio Consoles. Contact ADM Technology, Inc., 16005 Sturgeon, Roseville, Michigan 48066. Phone (313) 778-8400. TLX 23-1114. West Central Sales Representative, Gordon Peters, (817) 467-2990.

ADM[®]
The Audio Company

TOSHIBA'S PK-60 MAKES NEWS... THE SMALLEST, LIGHTEST NEWS/PRODUCTION BROADCAST CAMERA ON THE AIR. WITH A DIGITAL MEMORY THAT WON'T FORGET.

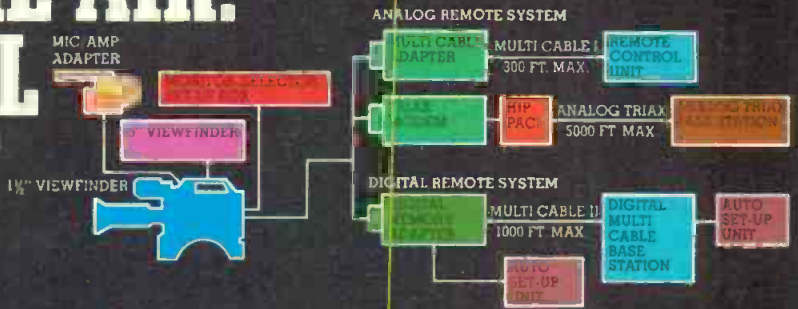

Here's the newest ENG/EFP camera from Toshiba. Just right and so light for broadcast news. It's this combination of features that make the PK-60 a small standout.



- 9.4 lbs.
- Small Size
- Reduced Power - 20.6 watts
- Outstanding Stability
- Digital Data Loc
- Microprocessor-based Auto Setup Unit
- Digital/Analog Base Stations
- Triax/Wireless Transmission

Digital Data Loc is Toshiba's digital memory that can be preset by the engineer and travel to the action scene.

Toshiba's versatile PK-60 with advanced new circuitry, unbeatable overall performance and ... Toshiba's celebrated quality.

Toshiba America, Inc.
Broadcast Electronic Systems Division
292 Gibraltar Drive, Sunnyvale, CA 94086
(408) 734-9172
Eastern Sales and Service
2971 Flowers Road South, Atlanta, GA 30341
(404) 458-9562

TOSHIBA
In Touch with Tomorrow

Circle 104 on Reader Service Card



HITACHI | HR-200



New from Hitachi

A Colossal One-Inch Step

One-inch is the VTR format of the future. It's too important a step forward for a scaled-up 3/4" or a scaled-down 2" system. It deserves to be totally original, with every advance designed in. That's how we approached the new Hitachi HR-200, after almost 20 years of experience making quad machines. The result: a one-inch Type C VTR destined to establish new broadcast standards everywhere. In every department, the Hitachi HR-200 is miles ahead of the one-inch competition!

Fast, sure, easy operation

Hitachi one-inch VTR's are loaded with features—many of them Hitachi exclusives. Like the brake release for easier threading. Both video and audio confidence. A "B-wrap" configuration, for reduced dropout. A *precision* moveable tape guide for easy loading, with an incredible 1-micron tolerance that's accurate for up to 2 million threadings! Plus a sloped design and easier-to-see top mounted drum for still easier threading.

Dazzling performance extras

Imagine shuttling a 1-hour tape end-to-end in just 80 seconds! It's possible, only on the Hitachi HR-200, because an internal air compressor injects a column of air into the tape guides to reduce friction and increase acceleration. The same air compressor provides air for the non-contact air drum, cushioning the tape when in the standby or fast shuttle modes. For fumble-free shuttling and jogging and fast editing, a single knob controls both. There is audio spot erase capability. And a Hall-Effect head on the third channel reads the time code more accurately, regardless of tape speed.

A microprocessor makes the built-in editor the most advanced you'll find today. And, just as important: it can be re-programmed to interface with editing systems of the future. Serial or parallel logic for remote control? Both have advantages, so Hitachi gives you both. Built-in cable compensation boosts the signal so you can use cable up to 300 feet.

Uniquely simple service

Serviceable components have been human-engineered for easy access and replacement. The PC modules are front-mounted and can be removed in an instant. The six heads come as a pre-aligned drum assembly that snaps out and snaps back in minutes.



HR-100 Portable Model

The HR-200 is available as a console, or for tabletop use or 19" rack mounting. Best of all, it costs no more than ordinary 1-inch VTR's!

Smallest Type C portable ever!

The HR-100 portable model has many of the HR-200 features, yet it's the smallest Type C portable in the world. And the most serviceable too, with plug-in PC modules. Die-cast uniblock construction makes the HR-100 durable yet extremely light. And like the HR-200, it has a non-dropout tape path. Plus an extended tape path for less edge wear, an auto back space assemble editor, and 3-way power with built-in battery pack, AC adapter or external DC.

Take a big one-inch step. See the New Hitachi 1" VTR's...today.

Hitachi...Tomorrow's technology today.

9 Regional Centers for Parts & Field Service
• New York • Chicago • Los Angeles • Atlanta • Cincinnati
• Dallas • Denver • Seattle • Washington, D.C.



HITACHI
Hitachi Denshi America, Ltd.
175 Crossways Park West
Woodbury, New York 11797
516-921-7200

BM/E

BROADCAST MANAGEMENT/ENGINEERING



Expanded news and the technology to support it have opened the way for the broadcast industry to develop its own high journalistic standards. This month's report looks at some of the ways broadcasters are establishing these traditions

Publisher
Charles C. Lenz, Jr.
Editorial Director
James A. Lippke

Editor
David Hawthorne
Senior Editor
Robin Lanier
Senior Editor
Stephen C. Miller
Senior Editor
Joseph DuBovy
News Editor
Eva J. Blinder
Editorial Assistant
Doug Damoth

Assistant Publisher
Djuna Van Vort
Creative Director
Gus Sauter
Marketing Services Manager
Christine Bunish
Production Manager
David Rose
Advertising Production
Deborah Foley
Editorial Production
Heldi DeVos
Reader Service
Randy Applebaum

Comptroller
Steven Abromowitz

FCC Counsel
**Lovett Ford and
Hennessey, P.C.**

JANUARY 1981/VOLUME 17/NUMBER 1

- 8 Broadcast Industry News**
Ampex/Signal merger finalized; U.S. court stays cable decision; VHD disc joint venture announced
- 23 Radio Programming & Production For Profit**
Keeping up-to-the-minute on sports and business via satellite
- 26 BM/E's Program Marketplace**
Profile of Radio Programming/Management
- 33 Television Programming & Production For Profit**
Taking it to the streets for public affairs at WDVM

41 Technology For Better Journalism

- 41 The Care And Feeding Of I-Teams**
Despite the headaches, many stations are finding investigative units worthwhile
- 47 Radio ENG: It's A Luxury No Longer**
What was once "fancy stuff" is becoming a necessity
- 55 All-News Television Debuts At KAUT**
Management thinks it can succeed with its gutsy experiment
- 61 ENG/EJ: A Series Of New Possibilities**
Specials and series are moving beyond the confines of rating periods
- 69 Airborne Repeaters: A Modest Proposal**
Relay options are the underutilized potential
- 72 Use The Weather Right, Hold Your Listeners**
Radio managements can fashion weather information from a wide variety of sources
- 85 EWG: Electronic Weather Gathering**
A variety of electronic systems make weather a vital part of TV station operation

-
- 93 SMPTE: No Surprises, But Solid Progress In Digital**
Little news was generated, but the march of digital continued
 - 99 SMPTE Exhibitors: Midseason Changes**
The show had its share of product introductions
 - 105 AES Convention: Panorama Of The Audio Future**
Once again, digital stole the show
 - 115 Testing Teletext: CBS Takes The Leap**
CBS's teletext experiment with KNXT and KCET begins this month
 - 121 FCC Rules & Regulations**
New rule might eliminate need for renewal hearing
 - 124 Great Idea Contest**
Win a calculator - enter the Great Idea Contest!
 - 128 Broadcast Equipment**
BM/E's survey of new products

BROADBAND INFORMATION SERVICES, INC.

295 Madison Ave., New York, N.Y. 10017, 212-685-5320, Telex: 644-001
Publishers: **BM/E—Broadcast Management/Engineering**
BM/E's World Broadcast News



BPA BM/E BROADCAST MANAGEMENT ENGINEERING (USPS 059280) is published monthly by Broadband Information Services Inc. All notices pertaining to undeliverable mail or subscriptions should be addressed to 295 Madison Ave., New York, NY 10017. BM/E is circulated without charge to those responsible for station operation and for specifying and authorizing the purchase of equipment used in broadcast facilities in the U.S. and Canada. These facilities include AM, FM and TV broadcast stations, CATV systems, ETV stations, networks and studios, audio and video recording studios consultants, etc. Subscription prices to others \$24.00 one year, \$36.00 two years, Foreign \$30.00 one year, \$48.00 two years. Air Mail rates on request. Copyright 1981 by Broadband Information Services, Inc., New York City. Controlled circulation postage paid at East Stroudsburg, PA.

NEW!

1600-1X

Post Production Switcher

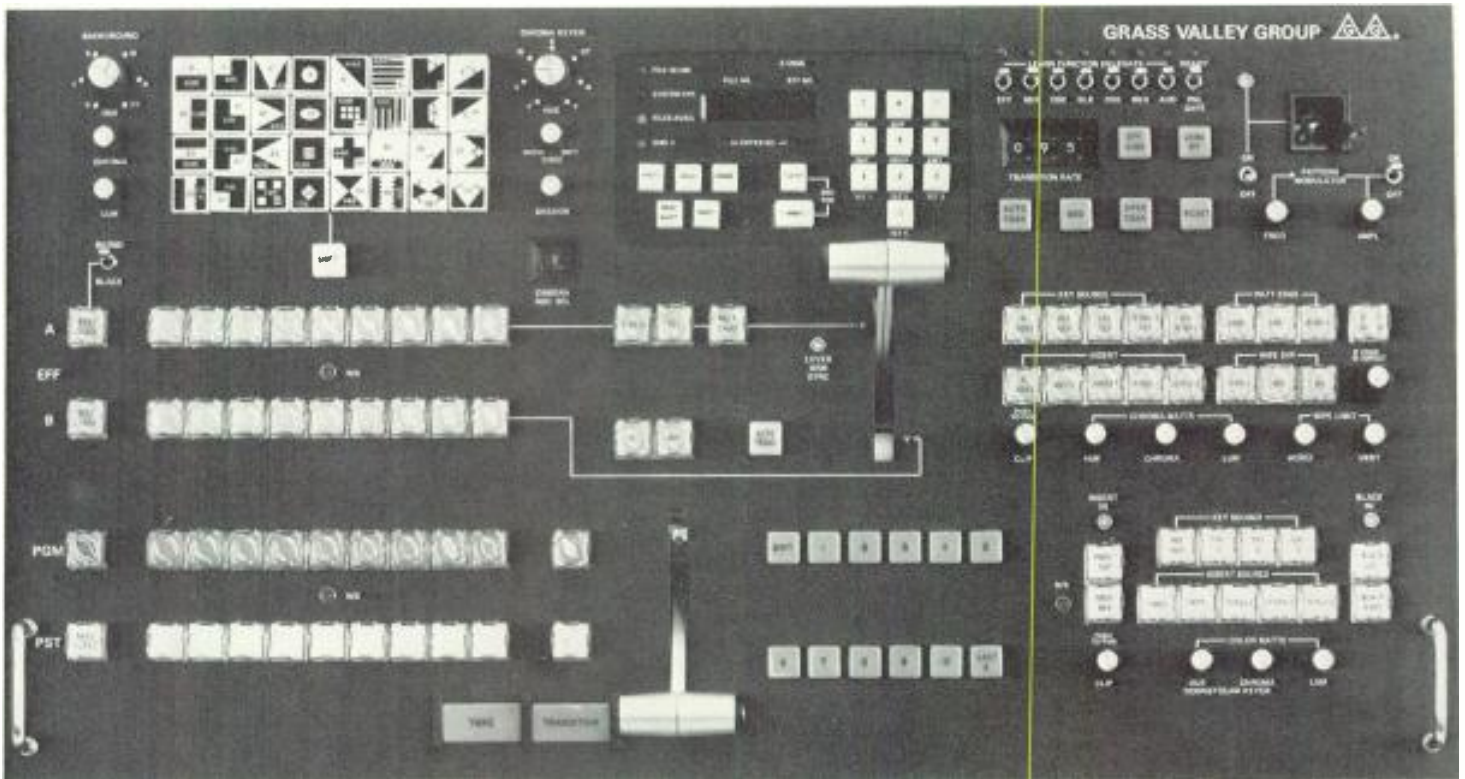

The 1600-1X heads a new line of GVG™ 1600 Series post production products featuring the E-MEM Serial Interface for in-depth computer editor control.

Standard equipment

in every 1600-1X is a new E-MEM™ II effects memory system with sE-QUENCER capability. Also standard are auto transitions in the

mix/effects, flip-flop mix, downstream key insert and fade-to-black.

Post production options

include the E-MEM Serial Interface, a new E-DISK floppy disk storage system, and a new E-MEM Audio system.

For further information

contact your nearest GVG sales office.

THE GRASS VALLEY GROUP, INC.

P.O. BOX 1114 GRASS VALLEY CALIFORNIA 95945 USA • TEL: (916) 273-8421 TWX: 910-530 8280

A TEKTRONIX COMPANY

Offices: WEST: 21243 Ventura Blvd Ste 206, Woodland Hills, CA 91364 (213) 999-2303 • SOUTHEAST: 1644 Tullie Cir NE, Atlanta, GA 30329 (404) 321-4318 • NORTH CENTRAL: 810 W Bristol St, Elkhart, IN 46514 (219) 264-0931 • NEW ENGLAND & MID ATLANTIC: Station Plaza East, Great Neck, NY 11021 (516) 487-1311 • SOUTH-WEST: Seminary South Office Building Ste 316, Fort Worth, TX 76115, (817) 921-9411 • MIDWEST: 3585 N Lexington Ave Ste 238, Arden Hills, MN 55112 (612) 483-2594

Circle 106 on Reader Service Card

BROADCAST INDUSTRY NEWS

Ampex/Signal Merger Finalized

The merger of Ampex Corp. into the Signal Companies, Inc., first announced almost a year ago (see *BM/E*, March, 1980), has been finalized.

The boards of directors of the two companies approved the merger last fall; subject to approval of the stockholders, Ampex should be part of Signal by this month. Negotiations were not without hitches, however; talks were actually called off in April by mutual consent. The new agreement calls for Ampex shareholders to receive 1.275 common shares of Signal for each common share of Ampex.

Headquartered in Redwood City, Calif., Ampex designs, manufactures, and markets professional audio and video systems, computer memories and data handling products, magnetic tapes, and accessories. It posted record

pretax earnings of \$7.3 million for the quarter ending November 1, 1980. Signal, a worldwide, multi-industry company with sales of over \$4 billion, owns the Garret Corp. and Mack Trucks, among others, and invests in Golden West Broadcasters.

U.S. Court Stays Cable Decision

The FCC's lifting of the cable TV syndicated exclusivity and distant signal carriage rules (see *BM/E*, September, 1980) has been stayed by the U.S. Court of Appeals in New York City. Acting on a petition from Malrite, Inc., owner of WUHF-TV, Rochester, N.Y., the court has ruled that easing of cable rules must wait until arguments from several parties, including the NAB, FCC, and NCTA, have been heard.

The court's move closely followed

the FCC's denial of motions for stay filed by a number of broadcast interests, including NAB, the Tribune Co., Field Communications, and (jointly) Hubbard Broadcasting, Midwest Television, Post-Newsweek Stations, and John Blair & Co. The Commission had previously extended the effective date for deletion of the cable rules from October 14 to November 14, but refused to stay the November date, citing alleged benefits to consumers that would result from lifting the restrictions.

NAB's president, Vincent Wasilewski, issued a jubilant statement on the occasion of the stay, saying, "We are obviously very pleased with the court's decision since a stay is given only when it appears there is a likelihood of success on the merits of the case . . . We are optimistic as to the final outcome." NCTA, not surprisingly, was "disappointed" and will argue for the deregulation.

NCTA and the FCC are scheduled to submit their briefs this month; a final decision will probably be reached by the spring.

WITS Realizes "Impossible Dream"

Fifty thousand watts, 24 hours a day — that was the dream of WITS-AM of Boston, licensed to Mariner Communications. The station, already operating at 50 kW during the day but reduced to 5 kW at night, wanted to make the power jump and a transmitter site move simultaneously, an "impossible" feat in its crowded area.

But WITS management and engineers refused to be daunted and went to work on the project, which took almost three years and an expenditure of nearly \$2 million for

engineering studies, legal fees, environmental studies, construction, equipment, and installation, according to WITS program director Chris Cross.

The new transmitter, a Harris MW 50, was installed in early November at the new Waltham, Mass., site, about 20 miles distant from the old site at Quincy. WITS was on-air as "New England's newest superpower" early last month, showing those who said "it couldn't be done" how wrong they were.

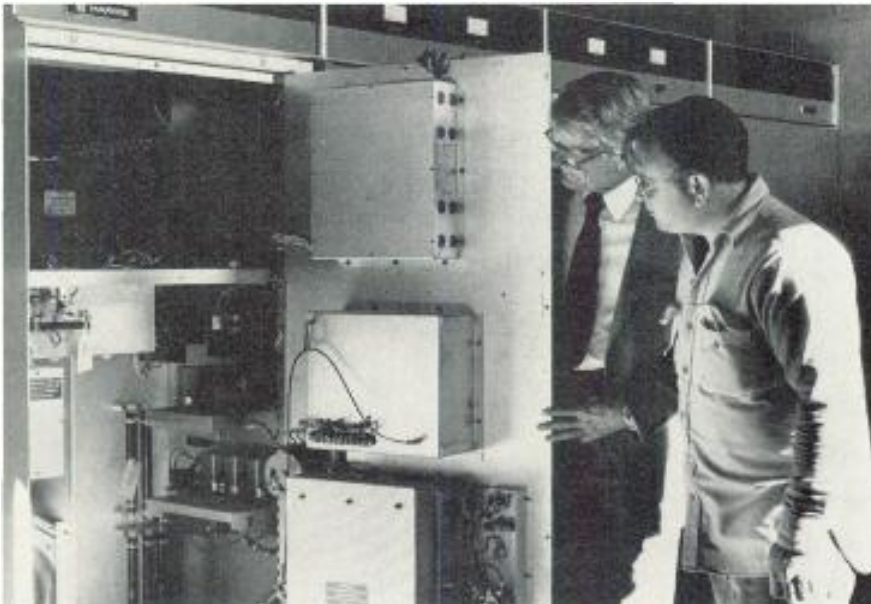

Jim Hampton (left), VP, engineering for Mariner Communications, and Dick Jolls, WITS chief engineer and project coordinator, get an inside look at the Harris MW 50

VHD Disc Joint Venture Announced

Three joint venture companies aimed at introducing the VHD videodisc system to the U.S. market have been formed by four international firms.

General Electric Co., Matsushita Electric Industrial Co. Ltd. of Japan (MEI), Victor Co. of Japan Ltd. (JVC), and Thorn EMI Ltd. of Great Britain announced the formation of the new companies last fall. VHD Programs, Inc., will produce and distribute videodisc programming; VHD Disc Manufacturing Co. will do just what its name implies; and VHD Electronics Inc. will manufacture disc players.

The cooperating companies originally announced tentative plans for the joint venture last summer (see *BM/E*, August, 1980). Their optical VHD (video high density) system employs a 10-inch grooveless disc with stereo capability; it plays for one hour on each side. When the system is introduced late next year, the companies plan to have a library of 200 discs available.

About 160 of the titles are expected to be movies, according to Gary Dartnall, president and CEO of VHD Programs and VHD Disc Manufacturing. Dartnall reports that the companies are negotiating with several major pro-

ADM

Control the complete audio spectrum



Our ADM 1600: modest but mighty

Although it's a desk-top model, our 1600 Series audio console offers a brilliant array of features and capabilities for handling the most demanding program material.

One of our new breed of consoles, the ADM[®] 1600 is available with up to 16 discrete inputs, 4 submaster and 2 master outputs. Combined with a host of pre-selector, buss selector and processor modules, the ADM 1600 creates perfect harmony with today's video. Like all ADM consoles, the 1600 is designed to exacting standards and manufactured to the most rigid tolerances. Each ADM console is backed by an exclusive 5-year warranty.

Make sure you control the entire audio spectrum. Contact ADM Technology, Inc., The Audio Company, 16005 Sturgeon, Roseville, MI 48066. Phone (313) 778-8400. TLX-23-1114. West Central Sales Representative, Gordon Peters. Phone (817) 467-2990.

News

gram distributors, including Twentieth Century Fox, Warner Home Video, Columbia, and MGM/CBS, for mastering and manufacturing rights. Although Dartnall will head both companies, they will have separate boards of directors. GE, Thorn, MEI, and JVC will all be represented; Thorn will be responsible for managing the business. The first disc mastering and pressing facility will be located in Los Angeles.

VHD Electronics, jointly owned by

GE, JVC, and MEI, has yet to establish a manufacturing facility in this country. Until it does so, its players will be produced by JVC and MEI for U.S. resale. The company expects the VHD system to be marketed independently here by GE, JVC, Panasonic, and Quasar.

Harris Corp. Acquires Automation Electronics

Automation Electronics, Inc., of Lafayette, Ind., has been purchased by Harris Corp.'s Broadcast Products Division, Harris announced late last fall.

The acquisition expands Harris's automation line to include radio business automation software; Harris already produces program automation equipment.

Gene T. Whicker, VP and GM of Harris Broadcast Products, said that the move would permit Harris "to market a single integrated system to handle all the automation requirements of radio stations." AE's chief product is the Autotron Star System, described as one of the few in-house computer systems that provide single entry, automatic processing, and direct interface to general bookkeeping. It will be manufactured for compatibility with the Harris 9000 program automation system.

Larry E. Zaiser, formerly president of AE, continues to manage the operation as director, automation sales. The entire company has been relocated to Quincy, Ill., to join the Broadcast Products Division.

Compact Video Leases Satcom, Buys Skirpan

In a move to broaden its range of production and post-production services, Compact Video Systems, Inc., of Burbank, Calif., has leased a transponder on RCA's Satcom 1 from Showtime Entertainment, Inc. Responsible for scheduling time on the transponder will be Compact's facilities subsidiary, Compact Video Services, Inc., which will also operate the satellite transmission center. The transmission center is currently under construction at company headquarters in Burbank.

The company predicts that the additional satellite services will increase business for another of its subsidiaries, Compact Video Sales, Inc., which manufactures mobile earth stations and production vehicles. Compact expects its sales of mobile uplink earth stations to be "significant" over the next year and a half.

Skirpan Lighting Control Corp., the New York-based designer and manufacturer of lighting control systems and solid state dimmers for television, theater, and commercial applications, has become the latest Compact Video subsidiary with its recent acquisition. The company's line includes computerized memory lighting systems, notably its Autocue and Cuelog systems.

N.J. Move Sought For RKO's Ch. 9

Acting on a proposal by New Jersey's U.S. senators, the FCC has proposed reallocating New York's Channel 9, now licensed to RKO General as WOR-TV, to a Jersey city. The rule-making is the latest of the Commission's attempts to establish better TV service for the Garden State, which cur-



The One For The Road



The versatile, self-contained QUANTAFONT production titlers, Models Q-V, Q-VI, Q-VII and Q-7A, are the perfect portables.

Any of these microcomputer based systems provide complete location titling: large resident memories, full raster title positioning, wide ranging character sizes, random page access, roll, crawl, flash and downstream video matte and more.

Production requirements determine the model. Enhancements include color backgrounds, colorized characters, borderline, shadow, upper and lower case fonts, proportional spacing, insert/delete and open/close editing, selectable page sizing and still more. QUANTAFONT Teleproduction Graphic Titlers... the perfect portable and great in the studio.



To Be Letter Perfect

System Concepts, Inc.
2440 South 2000 West
Salt Lake City, Utah 84119
Phone (801) 974-0992
TWK: 910-925-5684

Southwest Sales
1535 South Memorial
Suite 124
Tulsa, Oklahoma 74112
Phone: (918) 627-4151

Eastern and International Sales
16006 Waterloo Road
Cleveland, Ohio 44110
Phone: (216) 692-3410
TWX: 810-421-8192

Circle 108 on Reader Service Card



Best Picture:

SCOTCH ONE-INCH VIDEO TAPE

For the second year in a row, Scotch® 479 won the award for the best picture of the year in a test of one-inch video tapes.

We scored well in all of the twelve categories tested, but especially well in the categories that commonly represent picture quality: color dropouts, high frequency dropouts, chroma noise, signal-to-noise ratio and stop motion.

These were scientific, quantitative tests, conducted as you would conduct them yourself, with no room for brand bias. The meters didn't play favorites. The standards were the same for every brand tested. And we tested every brand.

These kinds of test results don't surprise us. We pioneered the invention of video tape. And we've been setting the standard for quality ever since.

Our quality has always been consistent from the first replay to the

last. In fact, our sophisticated binder and oxide coating are more advanced than the binders and oxides on some quad tapes. They had to be advanced to meet the special durability demands of one-inch video production.

So choose Scotch 479 for your one-inch video production. You'll find it looks good from repeated mastering all the way through post production. And we've seen the test results to prove it.



3M

News

rently has no VHF outlet.

UHF stations now serve New Jersey, which also receives signals from several New York and Philadelphia stations. If Channel 9 were relocated, its transmitter would probably remain at its current New York site, leaving the station's coverage area intact. WOR covers the northern half of New Jersey as well as New York City and its Long Island and Connecticut suburbs.

Opposition to the proposal was im-

mediate, both from within and without the Commission. Joining RKO in objecting to the plan was Multi-State Communications, which has been seeking the WOR slot for the past eight years. If the move were to take effect, Multi-Channel would stand to lose its competitive advantage over other applicants for the license; the Commission said it would consider approaches that would recognize Multi-Channel's long-standing interest in the assignment.

Dissenting voices from within the Commission were those of Robert E.

Lee and Abbott Washburn, both of whom called the action premature, pointing out that no action can be taken on the license until RKO General's appeal is settled. (RKO was stripped of the WOR license a year ago when the FCC found its parent company, General Tire, guilty of wrongdoing.) Further, if RKO wins its appeal the relocation proposal would probably not go through. Washburn discussed at length the Commission's past decisions on attempts to allocate a VHF station to New Jersey, saying that three FCC reports "have consistently rejected suggestions for reallocating a New York VHF station to New Jersey." Anne Jones concurred in a separate statement.

Setting Standards



Harris' Criterion 90 Tape Cartridge machines deliver performance and reliability that have set broadcast industry standards.

Here's why:

- Rugged ½" thick aluminum decks for extra stability.
- Heavy-duty hysteresis synchronous motor, with direct capstan drive for unmatched speed accuracy.
- 100% solid-state.
- Air-damped pressure roller solenoid with Teflon[®] coated plunger for quiet, easy operation.
- Exceeds all NAB standards.

- Every unit rigorously tested by computer controlled equipment for extremely high reliability.
- Field-proven amplifier with abundant head room and RFI immunity.

Even with all these features, Harris Criterion 90 Tape Cartridge machines are priced remarkably low.

For more information, contact: Harris Corporation, Broadcast Products Division, P.O. Box 4290, Quincy, Illinois 62301, 217-222-8200.



HARRIS
COMMUNICATION AND
INFORMATION PROCESSING

First SBS Launch: No Hitches

It was smooth sailing for SBS 1 on November 16 as the first of three business communications satellites lifted off from its pad at Cape Canaveral, Fla.

Operated by Satellite Business Systems, a joint venture of Comsat, IBM, and Aetna Life & Casualty Corp., the satellite went into its geosynchronous orbit — a little south of El Paso, Texas — without a hitch, with Comsat handing over control of the bird to SBS on November 20 after guiding it to its home. SBS 1, which was built by Hughes Aircraft Corp., will transmit voice, video, data, and facsimile information to businesses and industries via rooftop earth terminals.

SBS 2, to be launched in April, 1981, and SBS 3, for November, 1982 blast-off, are also being built by Hughes. The aerospace firm is also supplying 100 earth terminals for the SBS service.

Just previous to the launch, SBS signed a contract with U.S. Telephone Communications, Inc., for a 13-dish network for its Dallas, Houston, and San Antonio offices. The communications net is expected to run some \$6 million once equipment and installation have been totaled.

Associations Cool On 9 kHz Switch

Comments from three broadcast associations in the FCC's 9 kHz AM spacing proceeding (*BM/E*, October, 1980) show little enthusiasm for the switch.

NAB, NRBA, and ABES all submitted comments, ranging from cool at best to hostile. NRBA was most adamantly opposed, calling the idea "an ill-conceived, excessively expensive plan which is not adequately supported by hard engineering data." The radio group maintained that the reduction of channel spacing could lead to increased interference and reduced audio quality,

Circle 110 on Reader Service Card

World's first field Production system with automatic camera phase control from ASACA

The ASW-100 and ASW-100N is completely self-contained portable field production system requiring only connection of cameras for full operation. System components connect together quickly and easily.

The system provides full monitoring, switching, camera control, tally, and intercom facilities up until now available only in production Van or Studio Operation.

- Vertical interval switching with mix-fader and 12 special effects.
- Fully automatic sub-carrier phasing accurate to ± 2 degree within 360 degree range. Sync timing is also automatic. (patent pending)
- Camera controls including iris, master pedestal, R. B. gains, R. B. pedestals, and tally. Control modules are available for most popular ENG/EFP cameras widely used.
- Video monitoring for sources and line out put, and line wave form monitoring.
- Built-in audio mixer with compressor circuit. (ASW-100N only)
- Built-in sync generator with gen-lock to black burst.
- Cable compensation up to 1000 ft. (300 m)
- VTR control start, stop, record.
- Downstreamkeyer for use with titler. (ASW-100 only)
- DC 12V or any AC outlet.

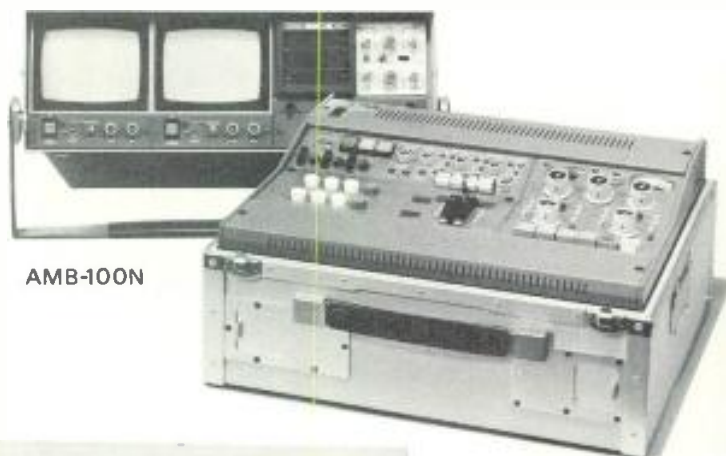

AMB-100N

ASW-100N



ASW-100

AMB-100

ASACA

ASACA CORPORATION OF AMERICA

Head Office 1277 Rand Road, Des Plaines, Illinois 60016, Tel. (312) 298-4380

155-B San Lazaro Ave., Sunnyvale, California 94086, Tel. (408) 735-7350

Circle 107 on Reader Service Card

www.americanradiohistory.com

News

and cited a recent FCC study by Moffet, Ritch & Larson that indicated the switch could cost almost \$20 million.

NAB continued its refusal to say yes or no to 9 kHz, but charged that the Commission had not proved to its satisfaction that the change would be in the public interest. Further studies are needed, NAB asserted, before a definitive evaluation of costs and benefits will be possible.

ABES took issue with what it saw as

the FCC's assumption that a change to 9 kHz was assured, with only implementation questions to be resolved. The association joined with NAB in calling for further study, especially on the impact of reduced spacing on existing and future radio service.

Comments In On First Class Tickets

The FCC's proposed elimination of first-class radiotelephone operator licenses (see *BM/E*, October, 1980) has sparked strong reactions, both pro and

anti. Lining up on the pro side are NAB, NRBA, and ABC, all looking forward to the possible furthering of deregulation.

NAB said it agreed with the FCC that the license exam is an inadequate measure of engineer competence and expressed concern over the existence of "cram schools" for prospective exam-takers. The industry could develop methods for testing and screening engineers, NAB said; alternatively, hands-on tests could be conducted at broadcast stations. The association also suggested several ways for improving the tests if they are retained, including schematic diagrams, computerized testing and scoring, and the participation of responsible broadcast organizations in developing tests.

ABC called the Commission's standards for licensee responsibility for technical violations too severe, asking that they be made "more realistic and reasonable." NRBA termed elimination of the first-class ticket "completely consonant with the concept of deregulation," pointing out that it was "in the individual licensee's interest to see to it that its signal is maintained in the best possible fashion by the best possible people."

Strongly opposing the license elimination was SBE, whose members scored the proposal in a recent survey (see last month's *BM/E* for details). Calling the license "a useful screening device," SBE predicted several potential problems that could result from its elimination, including downgrading of engineers' professional status, increased technical violations and interference problems, and possible hazards for untrained personnel. Around 150 individual license holders also responded in favor of retaining the ticket.

The Association of Broadcast Engineering Standards (ABES) warned that if the proposal goes through it could become increasingly difficult for small-market stations to hire qualified technicians. It suggested that the FCC conduct a feasibility study of the possibility of testing by a nongovernmental agency.

NAB Switches RPC Dates

The conflict of dates between this year's NRBA convention and NAB Radio Programming Conference was resolved when NAB rescheduled its meeting to August 16 to 19 "in the best interest of the radio industry."

When NAB first announced its meeting dates for September 20 to 23 — the exact dates of NRBA's convention — NRBA, clearly miffed, announced it would seek new dates. Faced with the difficulties of relocating a large convention at short notice, however, NRBA decided to stay put. The NAB action,

Announcing Model 909

9" Color For ENG

- Rugged/Compact/Portable
- In-line Slotmask CRT
- AC/DC Operation
- Pulse Cross Display
- EXT/INT Sync
- A/B Input
- Blue Only Display
- Black Calibration
- R-Y, B-Y Outputs For Vector-Scope
- Color/Monochrome Selector
- Twin Units For Rack Mount



SHINTRON
Worldwide

144 Rogers Street
Cambridge, MA 02142 USA
Phone (617) 491-8700
Telex 921497

Circle 112 on Reader Service Card



Picture shows Model 5462/16 TV Audio Console.

Price Surprise!

From 6 in/2 bus to 36 in/16 bus, Neve TV audio consoles are surprisingly price competitive and often available on short delivery. In addition to attractive pricing, Neve can offer you the best selection of purpose designed TV audio consoles to suit your

application. We pride ourselves on building the finest products in the world, which are simple to operate with unequalled technical performance and reliability. And we are the only console supplier with factory sales and service offices coast-to-coast, in New York (Connecticut), Nashville, Los Angeles and Toronto. Please write or call for our comprehensive TV audio console information package, so you can put Neve in your budget now. You'll be joining the Neve world of excellence!



Rupert Neve Incorporated Berkshire Industrial Park, Bethel, Connecticut 06801 Tel: (203)744-6230 Telex: 969638

Rupert Neve Incorporated 7533 Sunset Blvd., Hollywood, California 90046 Tel: (213)874-8124 Telex: 194942

Rupert Neve Incorporated P.O. Box 120907, Nashville, Tennessee 37212 Tel: (615)385-2090

Rupert Neve of Canada, Ltd. 2721 Rena Road, Malton, Ontario L4T 3K1, Canada Tel: (416)677-6611 Telex: 983502

Neve Electronics International, Ltd. Cambridge House, Melbourn, Royston, Hertfordshire, SG8 6AU England Tel: (0763)60776

Rupert Neve GmbH 6100 Darmstadt Bismarckstrasse 114, West Germany Tel: (06151)81764

Circle 109 on Reader Service Card

News

taken by the group's executive committee, was coupled with a resolution calling for "unified representation" of broadcasting before the FCC.

NRBA, as expected, "welcomed" the change of dates, but the group's president, Sis Kaplan, had sharp words for the "unity" resolution. "On the matter of a 'unified voice' for the radio industry," Kaplan retorted, "1500 radio broadcasters support NRBA precisely for the reason that NRBA is a

voice that speaks solely for radio." She indicated, however, that NRBA would consider any proposal that would benefit radio broadcasters.

SMPTE Members Elect New Leaders

The newly elected officers and governors of the SMPTE take office this month, beginning two-year terms. Taking over as president of the society is Ampex Corp.'s Charles E. Anderson, who previously served as SMPTE's executive vice president. Anderson's

activity in the society includes membership on engineering, television, national conference program, and local arrangements committees.

Past president Robert M. Smith will maintain a position on the SMPTE board of governors.

Stepping into Anderson's previous post is Joseph A. Flaherty of CBS Television. Maurice L. French of the Canadian Broadcasting Corp. is new editorial vice president; Charles A. Ahto of Tape-Film Industries was elected conference vice president. Other new officers include Harold J. Eady of Novo Communications, secretary, and Julian Hopkinson of Agfa-Gevaert, treasurer.

Starting their posts as SMPTE governors are:

New York Region: K. Blair Benson, Video Corp. of America; Calvin M. Hotchkiss, Eastman Kodak Co.; and Irving Rosenberg, CBS Television Network.

Southern Region: Eugene Myler, Eastman Kodak Co.

Central Region: Edward J. Blasko, Eastman Kodak Co. and Toni Roth, Image Transform, Inc.

Western Region: Gary L. Borton, Eastman Kodak Co.; Robert J. Ringer, Image Transform, Inc.; and Joseph A. Semmelmayr, Eastman Kodak.

Eastern Region: Thomas B. Keller, Public Broadcasting Service.

Canadian Region: Ray J. Brule, 3M Canada, Inc.

Go anywhere super-rugged SMPTE/EBU Edit Code Generator and Companion Reader that will give you an instant shot list.



The only portable SMPTE/EBU Edit Code Generators.

- Goes anywhere with your ENG crew. 2.0mA max. battery drain.
- Very light and rugged. It attaches to your VTR and produces accurate edit code as you shoot an important scene. More than 500 units in use worldwide.
- Model 640 for SMPTE, Model 641 for both SMPTE/EBU with LCD constant display and user code capability.



Model 644 Edit Code Reader plus off-line editing printer.

When Shintron builds a new product, we think of our customers' convenience first. Good Edit Code Readers are a dime a dozen today, but which one can generate an instant shot list? The only one is Model 644 Edit Code Reader/Raster Display and Shot List printer.



SHINTRON
Worldwide

Cambridge, MA 02142 USA
Telephone (617) 491-8700
Telex 921497

Connecticut Women Win License Battle

Bridgeways Communications Corp. has won its contest for the license of Channel 43 in Bridgeport, Conn. The new licensee is unique in that its 10 principals are all women — the first women to be awarded a U.S. television station license. Paving the way for Bridgeways was the withdrawal from the race of the only other competitor, owned by a Bridgeport businessman.

Bridgeways is 25 percent owned by its 10 principals, 50 percent by other women, and 25 percent by men. Laurel Vlock of Woodbridge is Bridgeways' president; her broadcast experience includes hosting a weekly public affairs show on WTNH-TV, New Haven.

Vlock indicated that the group had yet to decide whether to seek network affiliation or go independent. In either case, she said, the station would strongly emphasize local news coverage and women's issues. Other programming is expected to include children's shows and broadcasts aimed at the Hispanic community.

Costs for setting up the new station are expected to run around \$1.5 million, probably higher if Channel 43 goes independent. Startup is predicted for early 1982.

Circle 114 on Reader Service Card

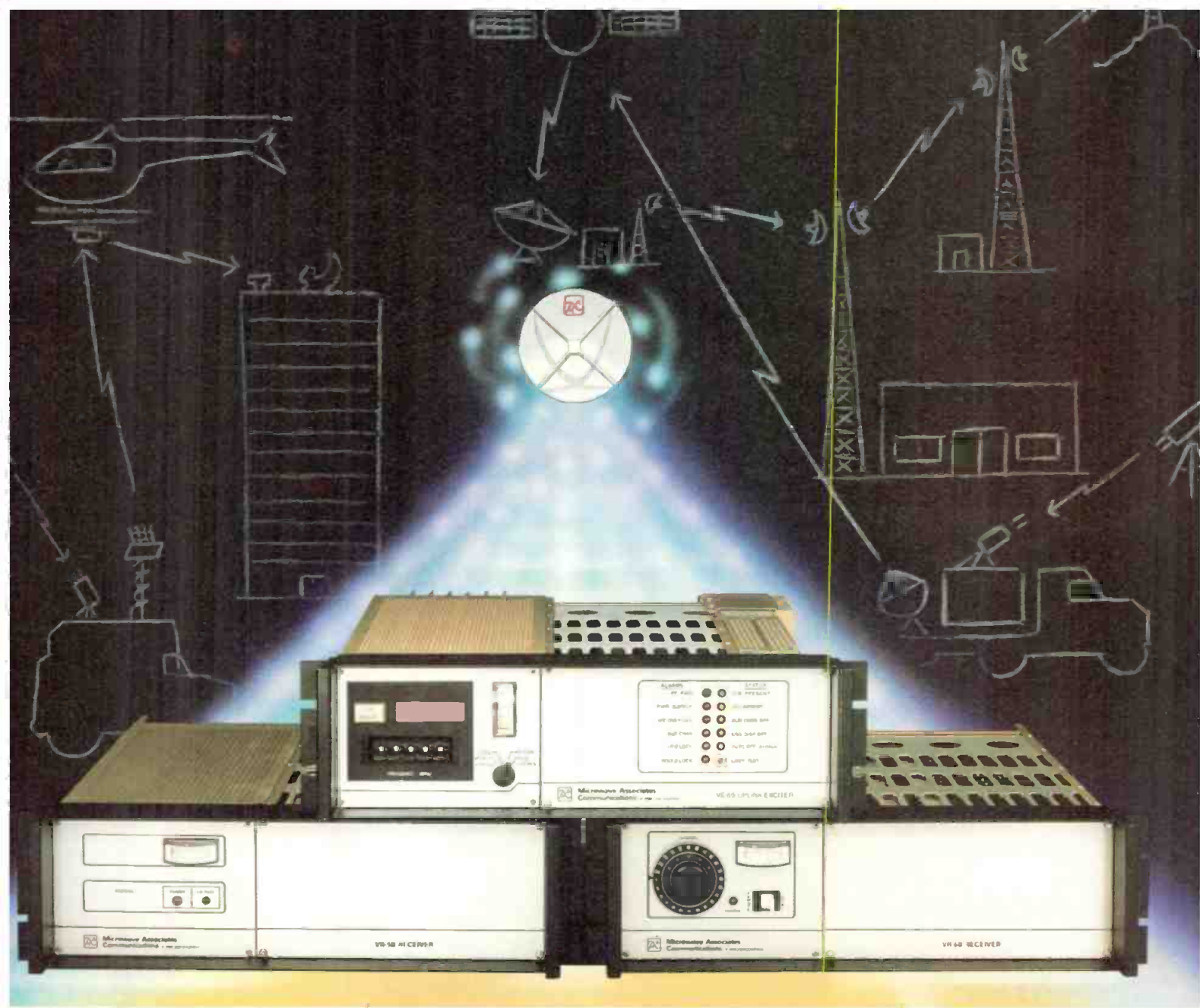

Make your Earth Station System part of a greater design.

If you're looking to get a new broadcast system off the ground, or expand the reach of an existing system, MAC engineers will supply the equipment configurations that are just what you need for your growing needs. We design, engineer, install and service every part of the total earth station system. To provide you with single-source accountability that brings down costs, improves operating efficiency and speeds up service. And MAC can integrate an earth station with a terrestrial microwave network to take care of your entire signal distribution system.

Our new VR-5B and VR-6B frequency agile receivers are the heart of any state-of-the-art earth station

system. The products of over thirty years of microwave experience, they feature full 24-channel capability, broadcast quality performance plus a built-in digital demodulator not found in any other receiver.

Our VE-6B Uplink Exciter is equally important to your earth station system. A frequency agile, high power exciter, it delivers up to +21 dBm output in the 5.925-6.425 GHz C-band. When we put these components together with the right amplifiers, antennas and custom-designed switching equipment, you get the most versatile reliable earth station system available.

All this advanced technology will bring you years of trouble-free performance; but should you ever need it,

there's our seven day, 24 hour service capability. One phone call brings fast action from your single source supplier. Like our systems approach, it's just part of a greater design to keep you broadcasting more efficiently, effectively and reliably. For more information call the Broadcast Division at (617) 272-3100 ext. 1806 or write us at 63 Third Avenue, Burlington, Mass. 01803

 Microwave Associates
Communications

 MA/COM
COMPANY

Circle 111 on Reader Service Card

News Briefs

The election of Ronald Reagan as President will have a **major effect on the FCC**, many broadcast observers are predicting. Replacement of Charles Ferris as Commission chairman is certain; two to four vacancies will open up for Reagan appointees by next summer. Reagan's FCC transition team is headed by Michael Gardner . . . Several House Communications Subcommittee members **lost their seats** in the Republican landslide, including chair-

man Lionel Van Deerling.

The FCC's revised AM stereo matrix puts **Motorola in the lead** over the other four systems (Magnavox, Harris, Belar, and Kahn). *Hall Radio Report* writes that the FCC is considering the marketplace approach or a lottery to select *the* system. Sixty-six percent of the respondents in a study recently commissioned by Harris Corp. said they'd like the FCC not to rush its decision; two-thirds wanted a single system designated and 89 percent called any major coverage reduction from stereo unacceptable . . . **Andrew Yoder**

was recently named chief of the Broadcast Bureau's license division.

The **International Television Association** will hold its thirteenth annual conference May 27 through 30 in Atlanta. For information, contact Dick Triche c/o Tricom, Inc., 10175 Harwin Dr., Suite 103, Houston, Texas 77036, (713) 776-0725 . . . Information Gatekeepers is sponsoring **FOC '81 East** at Boston's Hyatt Regency Cambridge March 24 to 26 and **FOC '81 West** at San Francisco's Hyatt Regency Embarcadero September 1 to 3. To find out more about the fiber optic shows, contact them at 167 Corey Road, Brookline, Mass. 02146, (617) 739-2022 . . . RAI Italian Television will host **INPUT**, the International Public Television Screening Conference, in Venice March 22 to 29. Submissions must be either on Sony U-Matic ¾-inch cassette or 16 mm film. Info from International Film Seminars, 1860 Broadway, Suite 1108, New York, N.Y. 10023, (212) 247-5536.

RCA Broadcast Systems will sell **Orrox Corp.'s** CMX 340X and 34X computer-assisted videotape editing systems in the U.S. and Canada under a non-exclusive marketing agreement recently signed by the two companies. CMX will continue to sell through its own marketing organization as it has in the past . . . **Studer Revox** has opened its new facility at 1425 Elm Hill Pike in Nashville . . . **Arriflex Corp.** has relocated its New York headquarters to 500 Route 303, Blauvelt, N.Y. 10913, (914) 353-1400.

ACI/Filmways will market and sell **Ampex** multitrack audio recorders under a sales agreement recently signed by the two firms . . . **Toshiba** is marketing the CED videodisc system, compatible with the RCA system, in the U.S. The unit will be manufactured in Japan by Toshiba . . . **Magnavox's** Magnavision videodisc player was launched in seven more cities in November, bringing the total markets to 32.

Convergence Corp. has formed a new division, **Animation Video**, which will manufacture a full-color video animation system. The syndicated TV show *The World of People* has purchased four Convergence ECS-103B editing systems for its editing and post-production center in Sausalito, Calif. . . . The Republic of China has ordered over \$250,000 of aural STL equipment from **Micro Control Associates, Inc.** of Cleburne, Texas . . . A new color slow-scan system developed by **Colorado Video** is being used to distribute *The Women's Channel*, produced by Satellite Syndicated Systems . . . Audio Plus Video International, Inc., Northvale, N.J. standards conversion firm, has installed the **Rank-Cintel** flying spot scanner.

Always SC/H Phased!

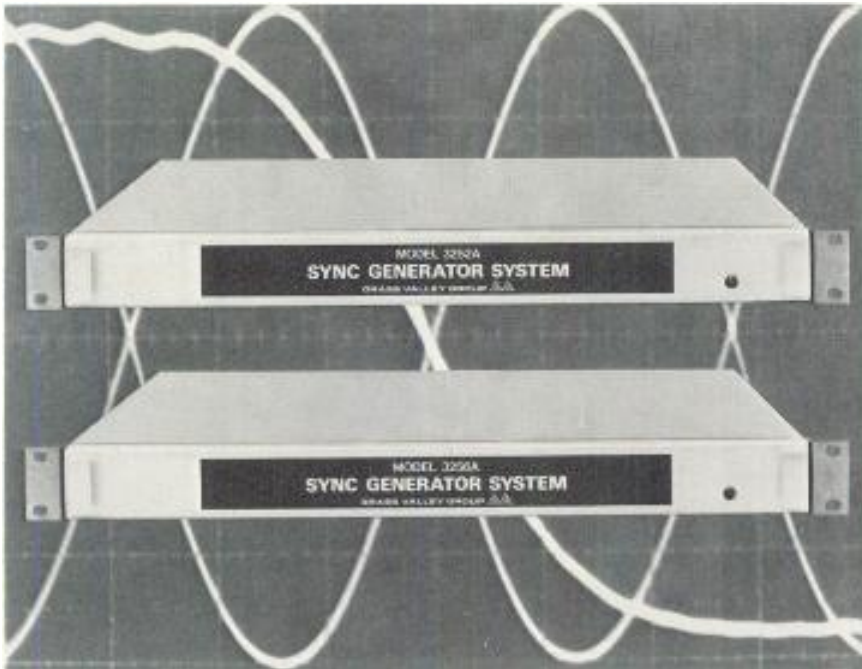

The Grass Valley Group 3250 Series* Sync Generators
Automatically maintain SC/H phased outputs. . .
even when genlocked to a non-SC/H phased source!

A new GVG publication

"Establishing and Maintaining SC/H Phase"
is yours free by circling the number below.

*Equipment shown with special promotional front covers.

THE GRASS VALLEY GROUP, INC.®

P.O. BOX 1114 GRASS VALLEY CALIFORNIA 95945 USA

Circle 116 on Reader Service Card

COMREX BUILDS BROADCAST NEWS EQUIPMENT

COMREX

P.O. Box 269 60 Union Avenue Sudbury, Massachusetts 01776 TEL: (617) 443-8811 TWX: 710-347-1049

Circle 113 on Reader Service Card

www.americanradiohistory.com

Better than 7 out of 10 ENG/EFP cameras



are equipped with FUJINON lenses.



F/2 22x12.5 zoom
with built-in
2X extender



New
F/1.7 14x9.5 lightweight zoom
with diascope
and 2X extender



New
F/1.7
12x9 lightweight
zoom with 2.2X extender

That makes FUJINON first.

More camera manufacturers, more networks, more stations and more production companies rely on FUJINON lenses than any other kind. They and you have made FUJINON first.

That may be because FUJINON has scored so many firsts. Such as the first ENG/EFP lenses to offer built-in 2X extenders. The first (and only) 6mm wide angle lens that can cover a 70° horizontal field of view and focus in as close as the lens surface.

Other firsts: a 3.5x6.5 wide angle zoom, a 17x9 zoom with built in 2X extender, a 14x9.5 lightweight, combining both a 2X extender and built-in diascope, and a 22x12.5 zoom with 2X extender (the ultimate EFP lens).

Other factors: The most effective optical coating system available — the patented Electron Beam Coating (EBC) — which contributes to FUJINON's unmatched clarity, high contrast and brightness with virtually no flare or ghosting. Adjustable back focus that speeds lens changing — eliminating internal camera adjustments. The most complete range of accessories for converting news and field cameras to studio use — including the only remote focus controls on the market.

Whatever the future brings, FUJINON will continue to be first. In variety, quality, and performance. FUJINON, tv's undisputed lens leader.

FUJINON

FUJINON OPTICAL INC. 
672 White Plains Road
Scarsdale, New York 10583
(914) 472-9800

West Coast Distributor:
FUJI OPTICAL SYSTEMS INC.
4855 Atherton Avenue
San Jose, California 95130
(408) 866-5466

FUJI OPTICAL SYSTEMS INC.
118 Savarona Way
Carson, California 90746
(213) 532-2861

Circle 115 on Reader Service Card

The Wave of the Future

***Introducing the First Solid-State, One Kilowatt,
One Tube UHF Television Translator in the United States***



The T-2400 Series 1000 Watt UHF translators define the high technical requirements of the decade. Proven design components assure quality and ultra-high efficiency to meet even the most exacting TV broadcast standards.

The new totally solid-state T-2300 Series 100 Watt television translator complements the T-2400 series. Both series feature modular construction including super broadband, interchangeable, plug-in, high-power, solid-state RF amplifiers.

Acrodyne . . . Traditionally the leader

- 1971 100% Solid-State Modular Translators
- 1971 Gated Sync Tip AGC System
- 1971 Automated Solid-State ID System
- 1974 LED Control Logic Display Panel
- 1977 Hi-Power IF Diplexed TV Transmitters
- 1980 100% Solid-State 100 Watt UHF TV Translator
- 1980 Ultra-High Efficiency, One Tube, 1 KW Translator

World-wide, these are some of the reasons why ACRODYNE translators continue to be considered first for sites utilizing satellite, terrestrial, microwave or off-the-air programming.

ACRODYNE

Acrodyne Industries, A Unit of Whittaker Corporation
21 Commerce Drive, Montgomeryville, Pennsylvania 18936
215/368-2600 TWX: 510-661-7265 800-523-2596

Whittaker

Circle 116 on Reader Service Card

www.americanradiohistory.com

RADIO

PROGRAMMING & PRODUCTION FOR PROFIT

Keeping Up-To-The Minute On Sports And Business Via Satellite

TWO MORE PRIME EXAMPLES of the "new net," the satellite-connected group that is totally outside the "old" nets, got underway just before this issue of the magazine appeared. Each is using its own uplink equipment to reach the satellite, Westar III in both cases. Both are using the Associated Press downlink pathways, reaching affiliates who have AP-supplied earth stations, or potentially any station with an earth terminal.

Sports every half-hour

Enterprise Radio, slated to go into operation January 1, will transmit via the satellite a five-minute sports news and analysis program 48 times a day, at 15 minutes before and 15 minutes after the hour. The program will bring the latest scores, of course, but also interviews with sports personalities, analyses of sports trends and developments by experts, "actualities" from sports events, and other similar material.

Will the radio broadcast industry absorb that much sports information on top of all the sports programs that many stations are already doing? The early response suggests that it will. At the time this was written (late November) Enterprise had between 20 and 30 stations signed up with new ones coming in at five to seven a week, making 40 or 50 likely by the January 1 kick-off date. That is probably enough to start on, with the strong presumption that actual operation will speed the join-up process.

In addition to the five-minute programs that come in around the clock, Enterprise will transmit two other series to subscribers. One is a 13-hour nightly (7:00 p.m. to 8:00 a.m.) sports telephone call-in show with a panel of experts and celebrities on hand to answer calls from listeners and discuss topics that listeners phone in. There will be an "800" number that callers can use at no cost to them.

The station can buy all or any part of this program, down to a single hour: each hour will be structured to stand on its own feet.

The third series consists of 2½-minute long sports features, with 20 a

week sent to the satellite — two every weekday, five on Saturday, and five on Sunday. These will include commentary on current events, tributes to individual accomplishments, memorable pieces of sports history, and other similar material.

Programmers who want more information about the Enterprise Radio sports programs should address the company at 40 Darling Drive, Avon, Conn. (203) 677-6843.

"Hot" business news

Another kind of programming reaching stations on the AP net is a series of business news shorts, each one minute long, with 17 sent out every day, by the Dow Jones Co., publishers of the *Wall Street Journal*.

Called the *Wall Street Journal Report*, the series will deliver business and financial news as it occurs, not only in the United States but also around the world. The news comes from the Dow Jones foreign and domestic bureaus, and is presented "live" in a style that can go on the air directly or be recorded

for later broadcast (but within a very short period; the material rates as hourly-current news).

The programs originate in the *Wall Street Journal's* newsroom studios, and go from there to the Westar III satellite. Thence they come down, on channels subcontracted from the Associated Press, to stations with AP earth terminals.

The AP net is going to be rich in varied programming; besides AP's regular newscasts, there will be the RKO programs, described in *BM/E*, September, 1980, and Enterprise Radio's sports coverage. Other software producers are negotiating with AP. RKO, at the time this story was written, had just completed a very successful live stereo broadcast of a rock group in New York's Carnegie Hall — details on that in a later issue.

Radio stations on the AP net or with their own earth terminals can get more information on the *Wall Street Journal Report* from the Dow Jones Co., 22 Cortland Street, New York, N.Y. 10007, telephone (212) 285-5466.



Ten-meter earth terminal antenna for both uplink and downlink is the type put into use on January 1 by Enterprise Radio at their Connecticut headquarters



**“Our
Auditronics
on-air and
production
consoles
pay off
three ways”**,

says Chuck Cooper, General Manager of WKOR in Starkville, Mississippi. “When it came time to rebuild this station, we wanted to go first-class all the way to the tower. Of course, that meant starting with first-class consoles for both on-air and production. But when you own a 1 kW station in a small market, you’ve got a modest budget to work within, and you can’t afford to make a mistake.”

“So we took our CE, PD and Op. Mgr. to NAB to look at everybody’s hardware with an open mind to make sure we got the best value for our money. We believe we got it in our two Auditronics 110 consoles. First, our on-the-air people love the Auditronics boards, and being able to show this type of equipment helps us to attract the level of talent we want.”

“Second, in a small market like ours, the stations do most of the commercial production, and the quality we get out of this Auditronics production board has helped us capture 80% of the production work in The Golden Triangle. Third, the Auditronics boards give us an audibly superior on-air quality that sells very well to our advertisers, and that’s the real bottom line.”

If you’d like to know more of what WKOR’s Chuck Cooper and 500 other satisfied users in both small and large markets have learned about Auditronics console quality and pay-back, circle reader service number or call us for complete information and the name of your nearest demonstrating Auditronics dealer.



auditronics, inc.

3750 Old Gerwell Road
Memphis, Tennessee 38118
(901) 362-1350

Circle 117 on Reader Service Card

www.americanradiohistory.com

Radio Programming

"Programmer's Package"

Analysis of radio audience behavior, in this period of tightening competition, is steadily moving toward high refinement. (See November, 1980 story on the Radio Information, Inc., computer service). Arbitron, with vast data routinely in hand, has announced a new analysis service for radio called "The Programmer's Package," which supplies very detailed data on who listens, and when, to the interested station and its competitors.

The Programmer's Package comes in automatically with the punching of a few buttons on the Arbitron AID computer terminal, which every subscriber to AID has in the station headquarters. The analyses appear on the terminal printout at typical computer speed.

Radio managements that do not subscribe to Arbitron's AID computer service can buy the same analysis indirectly through Arbitron.

The eight classes of data that come in the Programmer's Package are:

- Quarter-hours of listener frequency distribution, with quintiles, and their time spent listening to radio, and their time spent listening to any specific station.
- Audience recycling by daypart.



Arbitron's "Programmer's Package" lets stations call up detailed audience analysis information through their computer terminals

- Frequency of listening by day-part.
- Day-by-day percent distribution of Metro daypart cume.
- Station time spent listening by day-part.
- Tune-in, tune-out, and returning listeners by quarter-hour, Monday through Friday (average), Saturday, and Sunday.
- Top 10 stations sharing audience

with your station, and time spent with them.

- Top five stations sharing audience with the station being analyzed, and time spent listening by daypart.

Radio programmers interested in the Programmer's Package should address Arbitron at 1350 Avenue of the Americas, New York, N.Y. 10019, telephone (212) 887-1402. **BM/E**

Ready to go...

CHYRONI[®] RGU-1

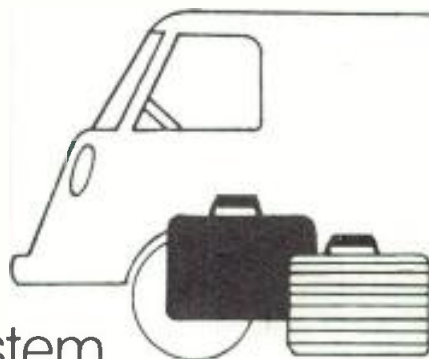

The portable graphics and titling system...

packaged to travel, to go where you go, as well as for in-house operation. Ingenious. Incorporating many features of the matchless **CHYRON IV**. From CHYRON — the electronic graphics people.

CHYRONI TELESYSTEMS DIVISION OF CHYRON CORPORATION

265 Bethpage-Spagnoli Road, Melville, New York 11747

Telephone: (516) 249-3296 ■ Telex: 144522 CHYRON MELV

Ampex International is exclusive distributor for Chyron Graphics Systems outside the U.S.A. For information contact your nearest Ampex sales office.

Circle 118 on Reader Service Card

Program Marketplace

Syndicators For Radio

Radio Programming/Management
15552 Arbor Place
Southfield, Mich. 48075
Tel. (313) 358-1040

IS BEAUTIFUL MUSIC slipping? The experience of Radio Programming/Management says "no." The Detroit syndicator, first covered in this column

in October, 1977, has used Beautiful Music since the beginning and has been growing steadily. Like other Beautiful Music syndicators, RPM has been forced to go outside the American market for a lot of the music (see the December article on Starborne for an update on this).

Tom Krikorian, president, in a *BM/E* interview reported a 35 percent increase in business during the 1980 calendar year. RPM has several formats. Krikorian says the "Contemporary Beautiful Music" is the most used by radio managements. In virtually every market

where this format has been strong in recent years, it continues strong.

But the care and effort RPM puts into producing the music and serving its client stations are undoubtedly essential elements of its strength. As earlier visits and revisits to syndicators have consistently discovered, success today means not only offering market-wise music, seamlessly produced, but also working closely with each radio management to help them realize their objectives and maximize their strengths.

Krikorian points out that his Contemporary Beautiful Music can be defined as the "top MOR hits of the past 20 years in mostly instrumental versions." This description does not express the specific character of the programs worked out for a particular station, however. These have been adjusted in close collaboration with the station management to fit each daypart, the station's competition, the audience responses collected by the station, and any other special factors that may affect that station's performance.

That kind of fine tuning has become a necessity, Krikorian says, to successful radio operation in the face of today's ever more intense competition. Every metropolitan market in the country currently receives far more radio signals than it can reasonably be expected to absorb. (Los Angeles, probably the outstanding example of this elephantiasis, gets more than 80.) Even in medium-sized markets the radio airwaves are overloaded. Syndication is becoming more important all the time under this pressure.

Krikorian points to another aspect of the radio business putting heavier pressure than ever on programming. Recent sales of radio stations show a trend toward capitalization at extremely high values. Even in very small markets, radio stations now sell for \$500,000 and up; a big-city station will run into several million dollars, no matter how unsuccessful it was before the sale.

To get the necessary return on such a sum, the new management will tend to adopt something that looks sure-fire in programming. Syndication with a good track record is attractive.

RPM has been refining skills and knowledge to meet these challenges. Its duplication equipment has been sharply upgraded over the past two years. An Otari 5050 system is now used, with duplication at 1:1 speed. Loudspeaker monitoring is supplemented with an oscilloscope. Every tape has at the headend a 1 kHz test tone for standard level and a 10 kHz tone for azimuth adjustment.

Master discs are played on Technics turntables. A radioactive bar neutralizes charges on the records; a KLH noise eliminator cuts down ticks and pops. Processing equipment helps

better believe it!

The Ferrograph RTS2 test set can reduce audio test time up to 30%.

Here's how. You connect only a single input and output lead to the component under test. You perform all routine checks for frequency response, distortion, wow and flutter, signal-to-noise ratio, drift, gain, input sensitivity, output power and more just by pushing buttons with this single instrument. You read the results directly in percent or dB so there's no arithmetic or guesswork.

Ferrograph RTS2 speeds your testing of tape recorders in all formats, turntables, preamps, line and power amps, equalizers and other signal processing components. It's easier and faster to use than separate test instruments; yet, it costs far less than other all-function test sets. For complete specifications, and details about how you can acquire the RTS2 at no risk, circle reader service number or contact: **Neal Ferrograph USA, Inc.** 652 Glenbrook Road, Stamford, Connecticut 06906, (203) 348-1045/Telex: 64-3678.

**NEAL
FERROGRAPH**



Circle 119 on Reader Service Card

Profit from the big picture... affordable, airborne ENG



The Hughes Helicopters 300C makes airborne Electronic Newsgathering affordable for most stations and marketplaces. The newest addition to the ENG field combines the Ahead of TIME technology of the Hughes 300C and microelectronics to produce the most economical airborne ENG system available.

The 300C's lightweight, durable design has proven its reliability in the toughest applications. All components are engineered for minimum maintenance and low operating costs. With a low initial investment the 300C provides stations with outstanding ENG capabilities. It provides a low vibration platform for better pictures. Its small size,

maneuverability and wrap around cockpit design allows you to follow all the action.

When equipped, with an I.M. Systems installed, GHZ-12 watt miniature portable transmitter, the 300C is the most cost effective newsgathering helicopter ever developed with the capability for live or tape delay coverage and ground-air-ground relay.

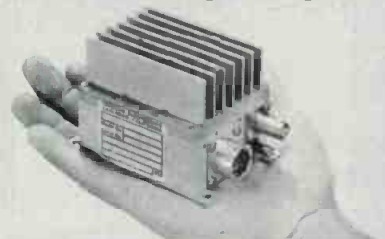

To obtain the complete picture on the Hughes 300C-ENG and a free demonstration, contact: North American Sales, Centinela & Teale Streets, Culver City, California 90230, USA, or call (213) 305-3054.



Hughes Helicopters
Ahead of TIME Technology

Circle 120 on Reader Service Card

Program Marketplace

bring poorly balanced records into line. A system on the floor helps drain static charges out of the studio.

Krikorian is satisfied that his technical quality is at the top. But he complains, as does every other conscientious syndicator, that quality control in the record industry is "terrible."

he refinement of the operation has extended strongly into knowledge of the market and investigation of what stations use what syndicators and how well it is working for them. RPM has undertaken a survey of all syndication-using stations to find out what they want in a syndicator, how they feel about syndication in general, and what they know about the subject. This survey is being carried out by in-depth telephone interviews. The interviews are introduced as completely free of sales effort — they are presented and carried out for information only. Krikorian says RPM has uncovered a number of "strange" preconceptions it tries to correct in education and sales efforts.

Knowledge of the specifics in each market has become, in fact, essential to planning expansion of the business as well as to serving clients, according to Krikorian. A good part of the operation's success depends on it.

Another aid to operation is a computer into which information about every piece of music is entered. The computer makes it fast and easy to apply non-repetition-of-artist rules, tempo sequences, and other selection constraints. Actual choices depend on the programmer's ear and musical experience, as in all successful operations of this kind.

In addition to Contemporary Beautiful Music, RPM is now supplying programming under the general titles of Classical Beautiful Music and Progressive MOR. Classical Beautiful Music, explains Krikorian, is more "conservative" than the Contemporary format, and works in situations where a "quieter" sound is what the demographic sector wants.

The Progressive MOR is an Adult Contemporary format. This can cover a wide range of music styles. The specific content, as noted already, depends on careful analysis of relevant factors by RPM and the station management.

RPM supplies "custom" introductions, recorded for each station directly on the reel of music. The intros and the music run together. Some syndicators supply custom voice material on a separate tape which must be synchronized with the music tapes: special equipment has been developed for this. Krikorian's clients like the all-on-one-reel

method, and his production operation is set up for it.

At the time of the interview (late November) Krikorian reported that RPM was in the final stages of preparing a new format — Country Music. The plan was to announce this in January, 1981, about when this article gets into print, and to be ready to ship the programs in February.

The decision to go into Country Music has grown out of RPM studies showing the strength of the music in many metropolitan areas. Krikorian noted, as have other syndicators, the trend toward something that can be called "Countryopolitan," a blend of Country with elements of Adult Contemporary, which seems to have a hopeful future on the radio scene.

The story of RPM's success, and many commentators on and analyses of programming trends in radio, testify to the large movement toward specialization, the fractionation of the audience, the necessity in radio programming to serve very particular interests in order to stay alive. A recent feature article in the *Wall Street Journal* showed the growing interest and awareness in the financial community of what is happening in radio. The managements of radio stations, of course, need knowledge of these trends more than any other group does. **BM/E**

Another Limiter?

Now Orban brings the natural, transparent Optimod-FM sound to a stereo compressor/limiter designed specifically for production work. Set our 418A once and forget it; from then on it guarantees clean, uniform carts regardless of operator skill and experience. The 418A's smooth, subtle broadband compressor prevents overload distortion; its separate high-frequency limiter guards against preemphasis-induced tape saturation.

You can use the 418A simply as a safety limiter — or put its full capabilities to work tightening up tracks. Either way, its accurate

stereo tracking makes it ideal for FM stereo today — or AM stereo tomorrow.

The time-saving 418A gets it right the first time — and *that* savings can mean more consistent quality and healthier ratings! See your Orban Broadcast Dealer for all the details or call for the dealer nearest you.

orban

Orban Associates Inc.
645 Bryant Street, San Francisco, CA 94107
(415) 957-1067

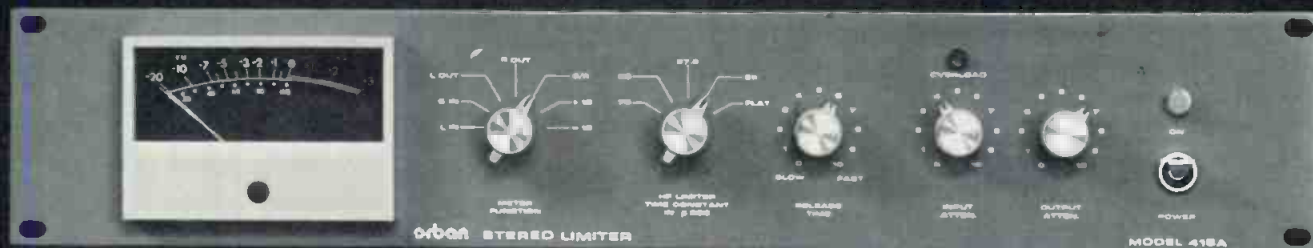

Protect your Video investment with the strength of ANVIL® Cases!

If your equipment is constantly on the road—or in the air—rugged, dependable ANVIL® Cases will make sure it arrives in performance-ready condition every time. We have a Case design to fit any Video component on the market. And we can customize your Case to carry those all-important cords, cables and connectors too!

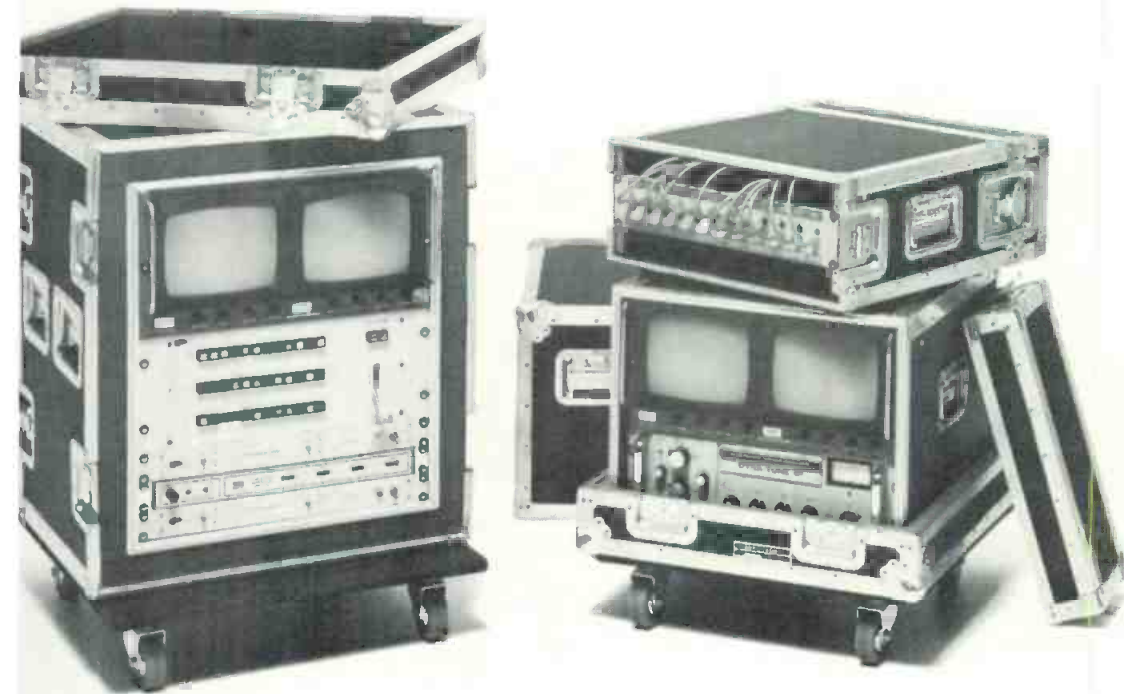

VIDEO RACK-MOUNT CASES ANVIL makes three types of Video Rack-Mount Cases. Shown at left is our all-new "Shock-Mount" design—the industry's first true shock-solution Travel Case. Double plywood walls are separated by a 2-inch layer of high-density polyfoam. Upper-right is our standard Front and Rear Clamp-On Lid style. Shown lower-right is our Pull-Over Clamp-Lid style, featuring an open front and back rack-shell, which fits into a standard 1-inch foam-lined Pull-Over Clamp-Lid style Case.



RECORDER CASES We make a strong Case for every video recording unit on the market. It's the best way to protect delicate alignment and calibration settings during transit.



COMBINATION/CAMERA RECORDER CASES Now any manufacturer's Camera can be safely transported with any recording unit. Once on location, just open the Case—hook up—and shoot!

For more information and the location of your nearest ANVIL® Dealer—call or write:
ANVIL® CASES, INC., 4128 Temple City Blvd., (P.O. Box 888), Rosemead, CA 91770 (213) 575-8614

Circle 122 on Reader Service Card

www.americanradiohistory.com

ANVIL®





Introducing the only $\frac{3}{4}$ " time code editing system that performs 20 automatic edits from multiple sources. The Panasonic 700 B-2 Series Time Code Editing System.

**700
B-2
SERIES**

Now Panasonic adds a new dimension to the speed and accuracy of time code editing with our new 700 B-2 Series Time Code Editing System. The AU-700 editing recorder, the AU-A70 programmable editing controller, and the AU-J10 multiple source adapter. Together they let you do what other time code editing systems don't: Perform up to 20 automatic, multiple-source insert and assembly edits. And the 700 B-2 Series is packed

with outstanding performance features.

The precision of direct drive.



Check out the excellent stability and precision of the AU-700's direct-drive video head cylinder and capstan servo motor. The superb performance and durability of our crystal-oriented HPF™ heads. All combine to produce an outstanding picture with horizontal resolution of 260 lines color, 330 lines

monochrome and S/N ratio of 46 dB color, 50 dB monochrome. You'll also get an edit with less video noise because video head switching has been moved to the vertical interval so it never shows up in the picture. At the same time, we incorporated DUB IN and DUB OUT connectors with separate Y/C signals and a flying erase head. And to keep that good-looking picture looking good, all circuitry is mounted in a durable annealed aluminum die-cast chassis.

The speed of microprocessors.

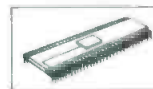

Another touch of ingenuity is the AU-700's microprocessor controls. Designed to work perfectly with the AU-A70 editing controller, they give you the speed, accuracy and versatility of full-logic, mode-to-mode switching. The AU-700 will accept SMPTE time code on a separate track or on audio track one as well as standard CTL pulses. And its electronic



Shown from left AU-700 editing recorder, AU-A70 programmable editing controller.

digital tape counter displays LED readouts of CTL pulses in minutes and seconds—even in fast forward and rewind.

Multiple source versatility.

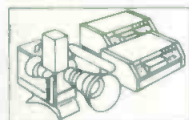

With our AU-A70 editing controller

not only can you generate and read time code pulses, microprocessors let it perform up to 20 time code edits automatically. Add an AU-J10 multiple source adapter and it will accept inputs

from two source decks and one live line plus perform A/B rolls. Microprocessors also let you automatically go to specific tape locations. You can also search both ways at speeds of 1/20X, 1/5X, 1X, 2X, 5X plus pause with picture. Other features include program check, program exchange, insert programming and overflow indication. For editing convenience, separate address time and lap time indicators are included. The AU-A70's error codes pinpoint any procedural

errors to avoid incorrectly programmed edits. The AU-A70 can also be used with any Panasonic solenoid-operated 3/4" and 1/2" VHS™ decks. For worldwide versatility, there is a built-in voltage selector that is compatible with 100V / 120V / 220V / 240V AC, at either 60 Hz or 50 Hz.

Total service capability.

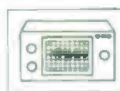

When it comes to servicing and maintaining the 700 B-2 Series, Panasonic backs you with a full net-

work of B-2 dealers, equipped with total service capability. Each has the parts, test equipment and technical expertise professional applications require. For further information, call your regional Panasonic office: Midwest—(312) 364-7936; Northeast—(201) 348-7620; Southeast—(404) 923-9700; Southwest—(214) 356-1388. The new 700 B-2 Series Time Code Editing System. Only from Panasonic.

Panasonic
VIDEO SYSTEMS DIVISION

GIANTS COME IN ALL SIZES.

Model Shown: 3106 in the new American Data Gold. Just one in a complete line of quality multi-level video production systems. Simple to operate, yet advanced in design and reasonable in price.

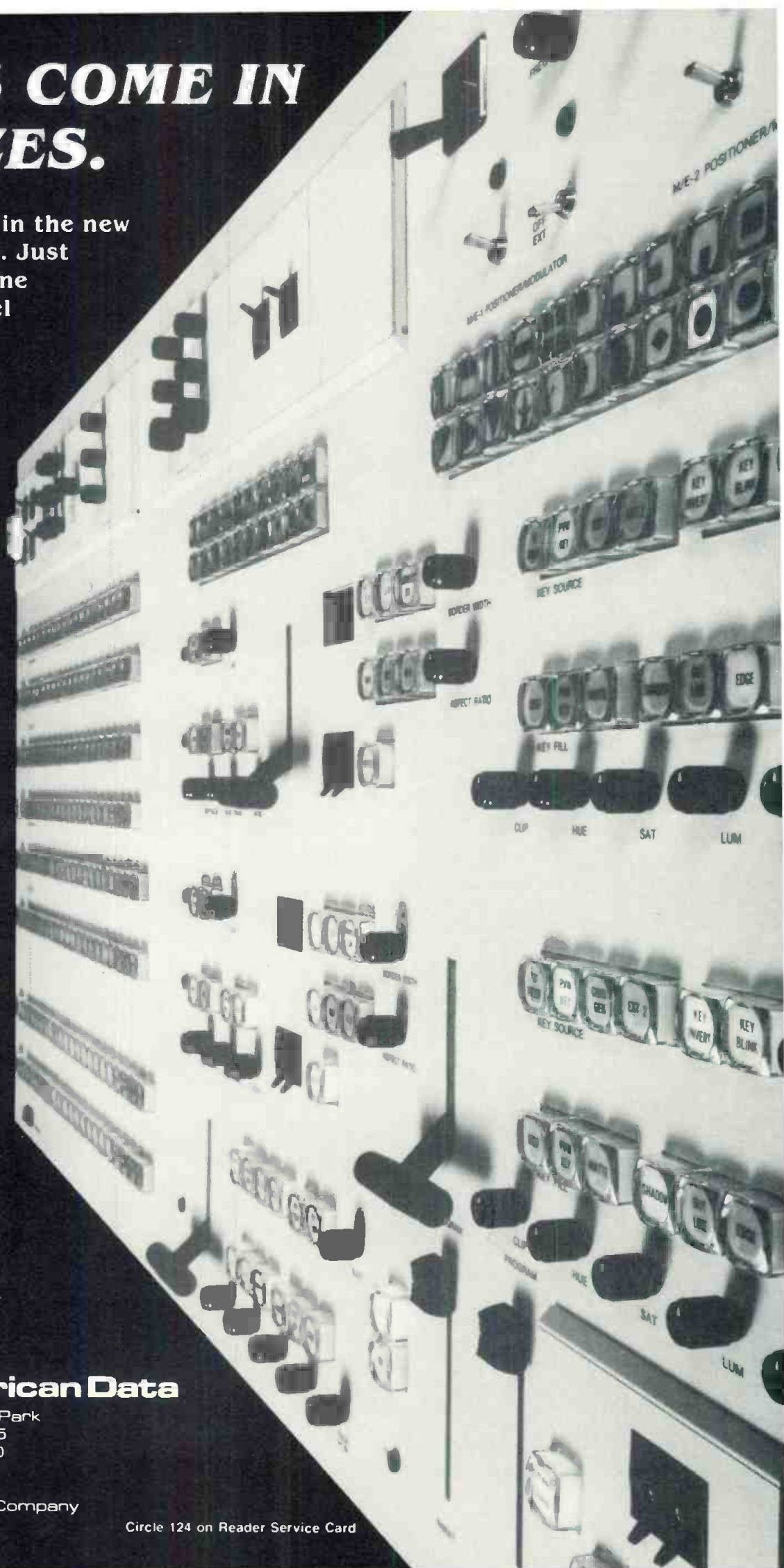

 **American Data**

401 Wynn Dr • Research Park
Huntsville, Alabama 35805
Telephone (205) 837-5180
TWX 810 726-2125

A North American Philips Company

Circle 124 on Reader Service Card

TELEVISION

PROGRAMMING & PRODUCTION FOR PROFIT

Taking It To The Streets For Public Affairs At WDVM

"PUBLIC AFFAIRS SHOWS are usually treated like stepchildren in most stations," says Pablo Sanchez, public affairs producer at WDVM-TV. His sentiment is echoed by other public affairs producers around the country who have what they consider the thankless task of producing broadcasts that have little respect within the professional community.

But Sanchez and some of his colleagues around the country are taking advantage of ENG technology to upgrade the production value and substance of public affairs programming, while keeping the cost down.

Neighborhood News Conference is a weekly show that deals with issues affecting the various communities within the Washington, D.C. metropolitan area. The broadcast has been airing Saturday afternoons for about two years. It is based on the concept that many issues that are important to local communities don't lend themselves to the traditional approach of studio "talking heads."

The problem with usual public affairs programming, many feel, is that it tends to favor the special interest groups which are well organized and have spokespersons available during the hours when other interested parties are working. Even if the tapings are done in the evenings, it is sometimes difficult to get working people to the studio because of family or other social commitments.

Scheduling and location are key

Neighborhood News Conference takes the approach that the best time to get all the participants together is on the weekends and in their own areas. This not only allows greater participation from the people involved but gives quick access to a visual presentation of the issues.

The format of *Neighborhood News*



Producer (and sometimes host) Pablo Sanchez introduces the week's topic to the audience/participants of WDVM's *Neighborhood News Conference*. The show aims for an EFP look with an ENG budget (Photo courtesy of Bruce Reedy, WDVM)



Cameraman/editor Dave Moubray shoots closeups using an Ikegami HL-77 attached to a Sony BVU 110 recorder. Shooting from the hip eliminates the strain caused by having the camera on the shoulder and having to bend down for several hours (Photo courtesy of Bruce Reedy, WDVM)

Introducing... the Editor-in-Chief.

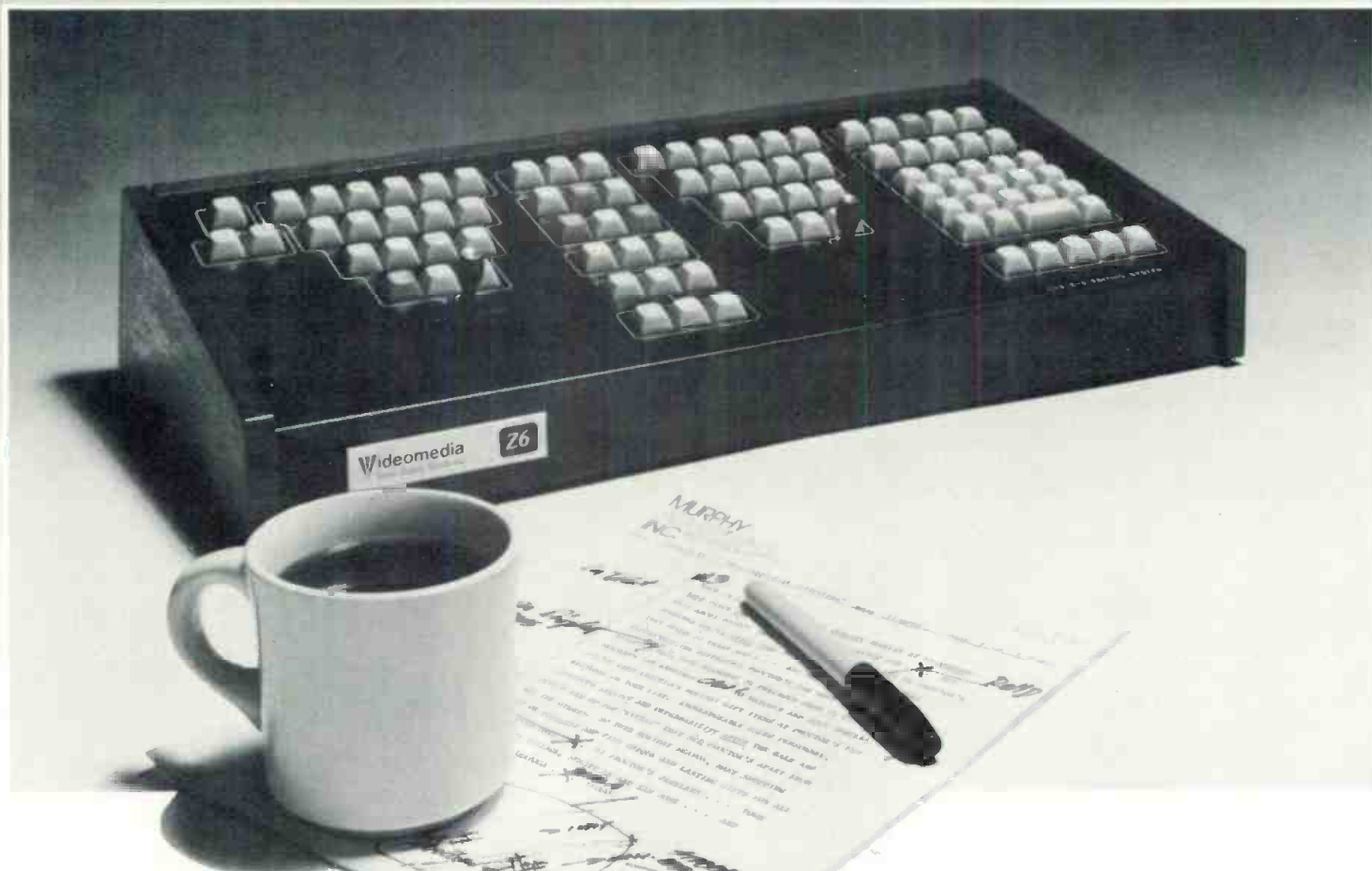

Stickler For Details

Fast, accurate decisions and a "mind" for details, that's why Z-6 editing systems are in demand by broadcast newsrooms throughout the country.

With a Z-6 system, you get frame accurate editing, plus all the useful functions of the SMPTE Time Code, *without* all the problems.

What's more, a Z-6 can track SMPTE Drop Frame or Non-Drop Frame, 24-frame film rate, or any other time base. And, it will "translate" codes for you, adding or subtracting real, decimal or mixed numbers for precise scene and program length computation.

Easy to Work With

Dissolves, wipes, animation, effects, split edits and text editing. The more arduous the editing session, the more you'll appreciate working with a Z-6. Since each key on the Z-6 has a definite, single function, the entire system is easy to use and understand.

Its Auto Edit feature and full look-ahead/behind logic simplify the handling of complicated editing tasks.

With a Z-6, you can pick in or out points on-the-fly; maintain "lip sync" throughout the entire tape during all editing procedures; and do A, B, C external rolls on one pass.

Then, when you're finished editing, you won't have to make a dub — because the Z-6 can automatically edit an exact duplicate tape for you.

Knows Who's Boss

When you're working with a Z-6 editing system, you are Chairman of the Board. Its microprocessor-based controls were developed by editors for editors. And, its features are designed to take the drudgery out of editing.

For example, the Z-6 automatically loads edit point locations so you can edit pictures instead of numbers. Its ability to randomly locate single frames on any tape in the system saves you time. And, its operator prompting messages are intended to prevent the type of errors which could result in the need for major re-editing.

Stays in Budget

Best of all, a Z-6 editing system is a financially sound investment. Just purchase the version that meets your *present* requirements.

If you don't need features like multiple source, effects or multi-event memory, you won't be penalized for not buying them.

Since every Z-6 editing system is fully upgradable, all you pay is the *difference* between the price of the model you own and the price of the model you want.

For details on the entire line of Z-6 systems, call or write today!

Wideomedia
Professional Television Systems

250 North Wolfe Road
Sunnyvale, CA 94086
Telephone: 408-733-6500

Circle 125 on Reader Service Card

TV Programming

Conference is not very different from other public affairs programs. It starts with an introduction of the issue and the people who are on hand to discuss it. A moderator keeps the discussion flowing, leads to breaks, and wraps up the broadcast with a summary of the various viewpoints.

What makes *Neighborhood News Conference* different is that the broadcast is shot all-ENG and on location. It is often taped outdoors with an audience of interested neighborhood people. "Once we establish the subject," says Sanchez, "we scout the neighborhood for locations." Two sites are always picked because most of the time (even in cooler weather) the aim is to do the program outside. If the weather is bad the alternate site, usually a school or community center, is used. "But the point," adds Sanchez, "is to keep it in the neighborhood."

The other key to producing a show like *Neighborhood News Conference* is the application of ENG technology in creative ways. The trick is to do an EFP remote without an EFP setup — not to mention the EFP cost.

Small staff can get big results

Along with Sanchez, there are an associate producer, two production assistants (one keeps track of the order of the speakers and the other times the show), two camera operators, and two other technicians for audio and recording. There is also a stage manager for cueing the host. But there is no director.

Sanchez explains, "we set up a formula for how to shoot the show" that keeps that look of a directed show with-



Not all Neighborhood News Conferences are on weighty subjects. Vic Pimentel (on camera) and Bill Clemens (on sound) are allowed some artistic freedom in the shooting of a dance performance by children at a neighborhood art center (Photo courtesy of Bruce Reedy, WDVN)

We have the best 2/3" tube for your EJ camera...now.

tube talk



P-8160 Leddicons®

The newest addition to the successful family of EEV Leddicon tubes.

The P-8160 is directly interchangeable with all existing lead oxide tubes.

Lowest lag and no blooming.
EEV Leddicons are rated the best for these image tube characteristics.

EEV 2/3" Leddicons meet the same high performance standards as the 1" and 30mm Leddicons, and are the newest extension to EEV's hallmark of high quality and reliability.

The P-8160 is the best 2/3" lead oxide tube available TODAY.

Call or write today for complete details.

* Registered Trademark of
EEV Lead Oxide Camera Tubes

At EEV... your image is our business.



EEV, INC.

7 Westchester Plaza, Elmsford, NY 10523, 914-592-6050
EEV CANADA, LTD., Rexdale, Ontario, 416-745-9494
English Electric Valve Co. Ltd., Chelmsford, England
Telex 851-99103

Members of the GEC Group of Companies

Circle 126 on Reader Service Card

THE NETWORKS' CHOICE. (AND EVERYONE ELSE'S.)

At Camera Mart, we've been a leading equipment supplier to broadcasters and producers for years. We're no strangers to the 'instant' needs, unexpected calls, tough standards and difficult operating conditions that are often S.O.P. in this rough-and-tumble business. But you probably know that...at least, when it comes to film.

What you may *not* know is, for the past few years, we've been quietly doing the same in *video*! Testing and selecting the leading equipment for performance and reliability. And offering a wide selection of production and post-production components and packages—on rental, lease and purchase plans with our customary flexibility.

But don't take our word for it: talk to our customers. You'll see why so many people the industry depends on, depend on us.



Camera Mart

THE CAMERA MART, INC.

456 West 55th Street, New York 10019
(212) 757-6977/Telex: 1-2078
Sales • Service • Rental



Circle 127 on Reader Service Card

TV Programming

out a director. One of the cameras is always on a wide shot of the audience and host. The other shoots closeups and cutaways. "Since we almost always use the same cameramen, it comes down to them having a feel for what the other is doing so they stay out of each others' shots," says Sanchez. "It also keeps the cameramen involved in how the show flows since they also edit for the dub-up."

At one point the camerapersons worked with an intercom, but it was a wired system and just increased the setup time and added to the power needs. "We're waiting for delivery of a wireless intercom," says Sanchez, "and that will help a lot."

When *Neighborhood News Conference* first went on the air there was an attempt to do the show "live-on-tape" with no editing. Since the cameras were not synced, the old film technique of using a clapboard was tried. The idea was to sync up the two 3/4-inch VTRs and run the signals through the production switcher. At that point a director would call the cuts between the wide shot VTR and the closeup VTR as the dub up to quad took place.

It was a nice idea but it didn't work. The closeup camera would be focusing on the speaker and the wide shot camera would be panning for reaction. There was no way to clean up the problem without an edit session. After enough problems of a similar nature it was decided that since there was almost always something that needed to be edited, why not set up a regular edit schedule on 3/4-inch so there would be a flawless dub-up?

It was also discovered that most of the issues discussed on the show contained enough material for two half-hour shows. Shooting multiple shows at each outing doubled the output and halved the cost, and with a taping schedule every other week allowed more time for pre- and post-production.

Because ENG equipment is used and the shows are taped in the neighborhood affected by the subject of the broadcast, it is easy to get cover material. Either before or after the main taping, one of the cameras can shoot in the area without taking up much travel time and still have sufficient material to meet the producer's needs. With the additional time available for preproduction the shots are already blocked, saving even more time.

Sanchez spends about a week on each half hour from pre- to post-production. And while that isn't much time, ENG allows a flexibility never before possible to concentrate on substance and production value and still stay within budget.

BM/E

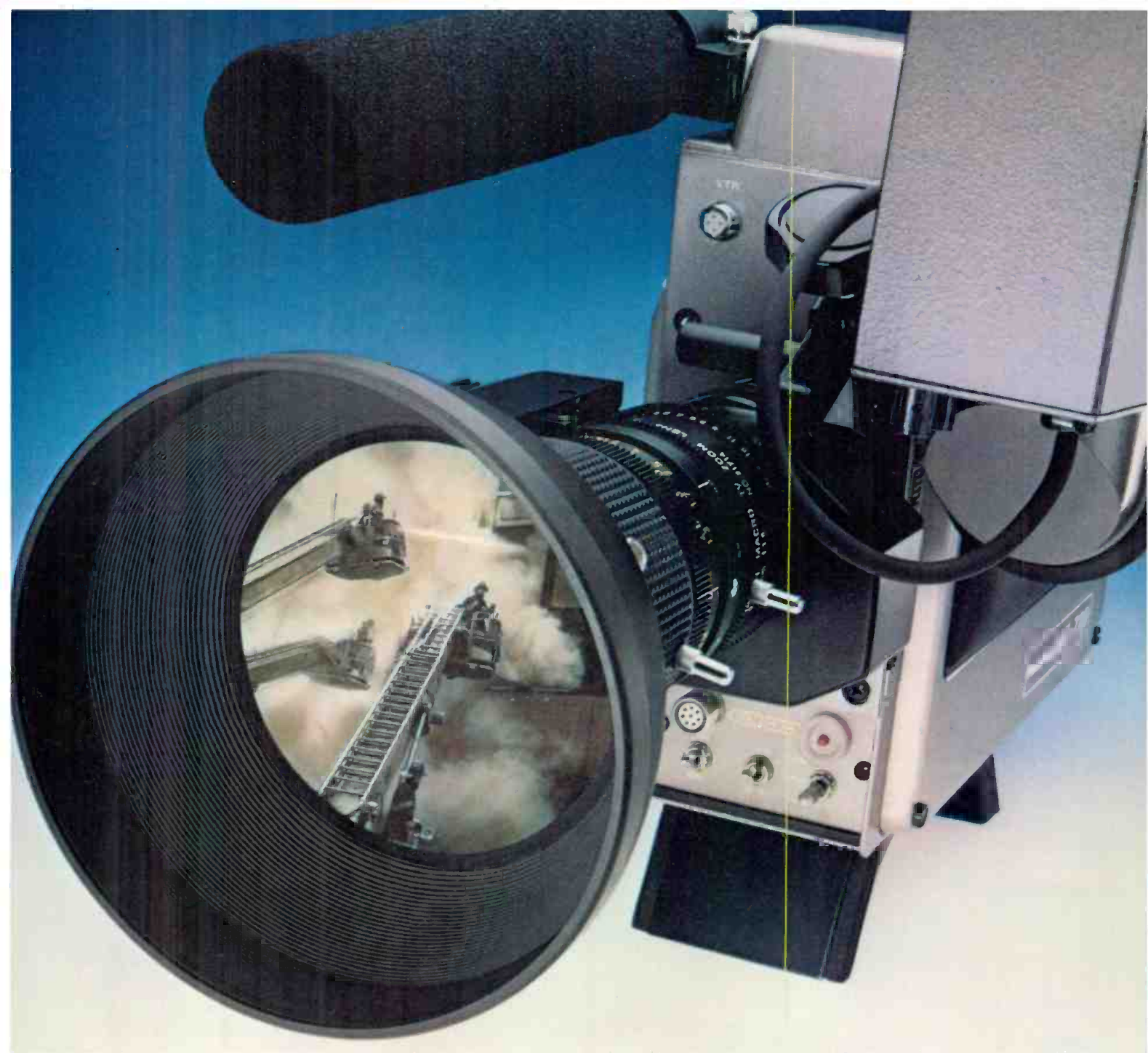

The big news is performance. The good news is price.

Once again Panasonic makes headlines with our newest ENG camera, the AK-710. And the reasons are simple: High performance Saticon® tubes plus prism optics—all for a newsworthy price of \$10,950*.

The AK-710's compact size, light weight and durable die-cast chassis make it a natural for electronic newsgathering. While the performance of a high-index optical system with built-in bias light and three Saticon tubes makes

it a natural for news broadcasting: Performance like horizontal resolution of 500 lines center, a S/N ratio of 52 dB and standard illumination of 200 footcandles at f/3.5. And for even more light-gathering capabilities, there's a 2-position high-gain switch.

You'll also get colors as intense as the action, thanks to the AK-710's automatic white balance circuit and built-in color temperature conversion filter wheel. And for minimal comet tailing,

the AK-710's feedback beam control stabilizes highlights that exceed normal white levels without reducing dynamic range or resolution.

Equally newsworthy is the AK-710's built-in genlock and adjustable horizontal and vertical blanking intervals. With them the AK-710 can double as a system camera. There's also an optional remote control unit, as well as a 5" CRT viewfinder for studio use.

So if news is what you're

after, go after it with the AK-710. A newsmaking camera from Panasonic.

For more information about the line of Panasonic broadcast equipment, call your nearest Panasonic office.

Northeast —(201)348-7620
Southeast —(404)923-9700
Midwest —(312)364-7936
Southwest —(214)258-6400
West Coast—(213)655-1111

*Manufacturer's sugg. price. (Lens not included.)
Saticon is a registered trademark of NHK
(Japan Broadcasting Corp.).

Panasonic
VIDEO SYSTEMS DIVISION

Circle 128 on Reader Service Card

If you think you own a CMX look and 34X edit

"Some day I hope to own a CMX." Occasionally we'll hear someone voice this wish. It's time for another look. With the design improvements and cost advantages we've built into today's 340X and 34X we think you'll want to include CMX in your future.

We have completed some advanced engineering and added new features to these computer-assisted editing systems, and we're delivering a brand new model, THE EDGE™. We've also come up with an impressive new way to generate CMX Edit Decision Lists using lower cost pulse count controllers. That's our EDL Logger.



CMX 340X—Real Editing Power
There are lots of reasons why the CMX 340X is the preferred video tape editing system. Check the features we've illustrated on these pages—Motion Memory, Gismo, List Management and Auto Assembly. Add to this a software enhancement package that includes Editing on The Fly (Sync Roll), Master/Slave, Jam Sync and Second Audio. Also control of a production switcher, either directly or through its intelligence option is standard.

And with our distributed processing you own the ultimate in expandability. A central processor, or "supervisor", communicates with the operator and our Intelligent Interfaces™ (I²'s), or "specialists" in control

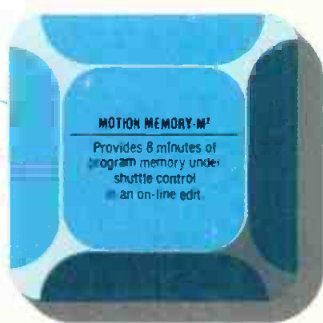

of any one of many post-production VTR's, switchers and other devices. When you expand you simply add an I² for each device. Built-in expandability means long-term

protection for your investment from the moment we install your CMX.

But the 340X is more than a combination of smartly-engineered electronic components. Installed and ready to use it is a complete system, a partnership that keeps you in post production. We think of it as our "total" commitment to you.

Today's 340X is a complete on-line/off-line system that includes a dual 8" disk drive for list input/output/copy, a printer, and a central processor designed to give you the option of MOS memory or core. All this editing power plus the widest variety of machine and switcher interfaces available.

So look again, Here's the real thing. A 340X in a three-machine configuration that's priced under \$55,000 in the U.S.

CMX 34X—Easy to Own
The CMX 34X is everything the 340X is, does everything the 340X does except control a



production switcher and include the software enhancement package. If you want the long-range advantage of expanding to a full 340X system, start with the off-line capabilities of the 34X.

You can put the most complex transition in the Edit Decision List. By adding CMX's General Purpose Interface option you can control switchers and effects systems.

A 34X, with three I²'s, an 8" dual disk drive for input/output/copy, a printer, a 5 × 1

cuts and preview switcher, and full CMX list generation and list management is \$34,500 in the U.S.

For less than the price of a 1" VTR you can own the system everyone prefers to work with.



can't afford to at today's 340X ng systems.



THE EDGE™

Innovation in Editing

The newest technological advance from CMX is SMART KEYS™. They are the heart of THE EDGE, an ingenious editing system that uses a CRT display to label 12 keys according to

their function. The system is so simple and logical that the next step appears on the screen.

THE EDGE is a two-source, one-record system that can do dissolves, produce a CMX-standard Edit Decision List with wipes and keys (in/out) and delayed transition events. It auto assembles or list processes with new record start and re-edit or ripple times. It includes two General Purpose Interfaces (GPI's) to control auto-transition switchers, digital video effects, character generators, etc. These GPI events, as well as splits (audio or video displays) and



dissolve/wipe durations, can be entered on the fly (MARKED). And locating any point in a scene is as smooth and easy as turning THE EDGE's Reel Motion Controls.

THE EDGE permits mixing of SMPTE time code and control track (pulse count) and works with 1", 3/4" and 1/2" formats.



Simplicity, flexibility, and versatility are hallmarks of THE EDGE. And its priced from \$17,000 in the U.S.

THE EDL LOGGER

The EDL Logger generates CMX Edit Decision Lists from a two-machine controller for 1/2 and 3/4" VTR's. This list can be either on paper tape, hard copy or both for use on a CMX. Wipes, dissolves and reel numbers can be included. It's priced at \$10,000.



THE PARTNERSHIP

It's all part of CMX's considered approach to editing—an approach that comes from perspective. We created the first practical video editing systems over 11 years ago and have consistently set new standards in the state of the art, year after year.

We've made sure that every one of the over 300 CMX video tape editing systems ever installed throughout the world is still operating today.

And it's this kind of commitment, not only to service and training, but to technological leadership that reflects the continuity of management at CMX/Orrrox.

CMX means creativity, expandability, efficiency and freedom from obsolescence. CMX means editing.

TM Orrrox Corp.

CMX
ORROX
The World Standard for Editing

Orrrox Corporation 3303 Scott Blvd., Santa Clara, CA 95050 (408) 988-2000 Telex 910-338-0554 Chicago (312) 325-8488/Los Angeles (213) 980-7927/New York (212) 371-1122 International Representatives: Magna Technics Pty. Limited, Artarmon, N.S.W., Australia/Totsu, Tokyo, Japan/TeknoMerica, S.A. Mexico City/F.W.O. Bauch Ltd., Herts, United Kingdom/Thomson-CSF, Gennevilliers, France/GTC GmbH, 2070 Grosshansdorf, W. Germany

Circle 129 on Reader Service Card
www.americanradiohistory.com



You wanted a low cost, high quality TBC Framestore Synchronizer? Now you've got it! The Microtime 2520

Now there's a TBC/Framestore Synchronizer that combines superior performance and low cost while maintaining the same high standards for quality built into all Microtime digital video and video processing equipment.

The 2520 is designed for use in broadcast and sophisticated industrial, educational, and CATV applications. It synchronizes network incoming and remote satellite feeds — all locked to station and provides the capability to handle any 1/2" or 3/4" heterodyne VTR with or without capstan servo.

On location the 2520 provides hot switching of multi-camera feeds with highly transparent performance.

The unit will function as an infinite window Time Base Corrector with Microtime's exclusive Hetrocolor™ circuitry for transparent heterodyne VTR processing.

Use it in the studio as a dedicated TBC, for feeding remote VTR video for lock to station or live playback on air. No advance reference link to VTR is necessary — just a single cable video feed via Telco, microwave, or satellite.

The optional remote control panel provides the choice to freeze either field one, field two or a full frame of video.

With the 2520 you can have high quality plus the superior performance of a framestore synchronizer for under \$19,000.

In addition to the 2520, Microtime also manufactures the broadest range of Time Base Correctors and Synchronizers anywhere — your choice of processors starting for under \$5,000.

Contact your nearest Microtime Distributor or call us directly for a product demonstration and complete details.

MICROTIME

MICROTIME, INC., 1280 Blue Hills Avenue, Bloomfield, CT 06002 • (203) 242-4242 • TWX 710-425-1165

Circle 130 on Reader Service Card

THE CARE AND FEEDING OF I-TEAMS



Investigative units can bring prestige, glory, and ratings. They can also bring headaches, lawsuits, and added expense. The benefits of I-teams, however, are encouraging more and more broadcast managements to make the commitment.

WRC-TV REPORTER Lea Thompson was living out a reporter's fantasy. She was in the Oval Office standing behind the President as he signed into law a bill that would not have existed without her investigative reports. As one of the reporters in her station's investigative unit, she discovered that two brands of baby formulas did not contain all the nutrients needed to keep an infant alive. The products were still being sold and the federal government apparently had no legal way to prevent it. Thompson aired these facts in a series of reports. Almost immediately, Congress passed a bill setting standards and giving the Food and Drug Administration the power to enforce those standards. President Carter said, "This law would not have been possible without the work of reporter Lea Thompson."

The history of investigative units is short. The first organized investigative unit at a television station was put together about four years ago at WBZ-TV in Boston. Then-news director Bill Aber recalls that he was asked to submit a proposal to Group W for an investigative unit. "I thought what I wanted was outlandish at the time," he relates. "What you would need was a staff of about a half-dozen people with a separate budget and their own equipment."

But Aber thought that the really outlandish part of his proposal was that for the unit to operate properly it would have autonomy — no pressure to meet quotas or be subject to production time schedules. When an I-team report was ready was to be determined by the unit alone.

When Aber got the word that his I-team concept had been approved by Group W management in New York, the first question he asked was, "In what form?"

"In the form you proposed."

It was the kind of commitment that few broadcast executives had made before. It was as close to carte blanche as corporately possible. That Group W commitment spawned a new form of broadcast journalism that was done very rarely before — long-term serious investigations. "The value of I-teams," says Aber, "is that they get local stations out of the habit of always reacting to events."



WRC's Lea Thompson (second from left) looks on as President Carter signs the baby formula bill which was introduced because of her investigative series

Other stations around the country have accepted that viewpoint. Currently there are about two dozen full time investigative units operating. That number has been higher, but I-teams are not without problems. Still, there is an intense interest among news directors and station managers about the concept of investigative journalism done on television.

The Group W concept of I-teams is still probably the "purest." The I-team unit is completely self-contained. There is an I-team manager, one or more reporters, a like number of producers, a researcher, a full-time crew, and editor, with separate gear and its own budget. The unit reports only to the news director, not to an assignment manager or executive producer. The only contact with the rest of the news department is when an I-team report is broadcast; the information is passed on so that any follow-up reports can be done by the regular reporters on staff.

I-Teams



Not all investigative stories involve hidden cameras and wireless microphones. Cameraman Skip Brand and soundman Peter Janen of WBBM shoot a transit story aboard a moving bus

WRC-TV news director David Nuell set up his investigative unit, called the Investigators, about two years ago. The first place he went for information after the O&O division decided to set up I-teams was to Group W. "I got Bill Aber to share some of the secrets of the I-team in Boston," he explains.

Nuell uses some of the I-team structure but has dropped the I-team manager. A crew and editor are assigned to the unit from the regular technical pool when needed. Another departure is that Nuell makes extensive use of college interns for research assistance. He stresses, though, that not just any interns will do: "We have a long-standing agreement with George Washington University which provides law students . . . and they provide a lot of the backbone for the research on some of the projects."

If any market can be said to be having a love affair with the notion of investigative units it is Chicago. One reason is that the market sports three competing O&Os with the megabucks to commit to large-scale I-team maintenance. Another reason is that there is a long history among Chicago journalists of all stripes for muckraking. A final, only slightly tongue-in-cheek reason comes from Peter Karl of WLS-TV's Target Seven unit: "Chicago is so corrupt that almost everything you touch can be a very, very good story."

All this combines for a lively competition among the various investigative units. One cynical Chicago source says, "You get the feeling that they are afraid of being caught with an I-team gap." It may not have anything to do with competition, but WBBM-TV has gone the other stations two better. It has three units, though at least one is geared more toward providing "instant in-depth" reports on developing stories. Even our cynic concedes that the competition has led to "some damn fine reporting on a regular basis."

Chicago has also added a new development to the evolution of I-teams — cooperation with the newspapers. It is almost standard procedure for a station and one of the

papers to work on a story jointly and break it simultaneously, each giving full credit to the other medium. It seems natural as a cooperative effort. From the management standpoint it can cut down costs by splitting the expense with the newspaper. From the journalists' standpoint it adds additional trained minds to ferret out information.

If there is one thing that everyone agrees on about the care and feeding of I-teams it is commitment. According to WRC's Lea Thompson, "Investigative reporting is a different animal. You have to go against [management's] very traditional way of looking at things. You have to be willing to have a reporter that rarely gets on the air. You have to be willing to let a crew sit there with the meter running. You have to run the risks of threats and lawsuits. And you have to be willing to spend money on projects that may not turn out."

"You have to have a commitment from the top," says John Spain, news director at WBRZ-TV, Baton Rouge. For six years Spain worked as an investigative reporter before becoming news director. Having been on both sides, he speaks with conviction. He doesn't believe that he would have been able to do the kind of work possible if the management "didn't have a real commitment to journalism."

Even with the commitment from management, another key to supporting the efforts of an investigative unit is, according to Spain, "a good attorney." The legal aspects of doing investigative journalism can be ticklish. The problem is not so much inaccurate facts, but occasional legal technicalities as to how those facts were gathered. Did the reporter misrepresent her- or himself? If sensitive documents are involved, how did the reporter get them? When can you record a telephone conversation without informing the person at the other end? Are there any local laws about photographing people in public places? Is a restaurant a public place and can you tape there without permission? When is confrontation harassment? Good liaison with your legal counsel can save costly litigation later.

"Fortunately for us," says Eric Ober, WBBM-TV news director, "two of our investigative reporters have legal training." But Ober feels that most good journalists doing investigative work are aware of the legal ramifications of what they do. One reporter who probably holds the record for court appearances concerning his investigative reports says, "It doesn't hurt if your station has several million dollars in libel insurance." Incidentally, this reporter has never lost a case.

Dave Nuell says that you can judge the success of an investigative report on what he calls the "three Rs" — results, recognition, and ratings. After a recent viewing of the tape of Thompson at the signing of the baby formula bill, Nuell remarked, "Who wouldn't want to have a reporter who can deliver that kind of result?" Recognition comes from effective promotion. Nuell continues, "You've got to have the report done far enough in advance to make a transcript and a press release so that when you put it on the air you have a good chance that some news agency other than your own will pick it up and run with it." As for ratings, it is still too early to tell, but WMAQ in Chicago has been able to track positive trends when investigation reports are aired.

If the last point proves to be true, it follows that if a station takes care of its I-team the I-team can help feed the company coffers.

BM/E

Introducing
NEC's all-new

MNC-81A



The "new generation" ENG/EFP camera with a difference!

Get a headstart on the 1980's with NEC's newest "state-of-the-art" ENG/EFP camera: the MNC-81A.

Designed to meet today's more stringent requirements for highest-fidelity color reproduction, the MNC-81A features outstanding colorimetry matched to that of broadcast cameras; with f/1.4 high-transmission prism optics; a choice of pickup tubes: Saticon®, Plumbicon®, or Diode Gun™ Plumbicon®; a signal-to-noise ratio of 54 (± 2) dB; 4-position gain control with up to +18 dB additional gain for low light level operation; plus all the *automatics*, built-in indicators and features that have become standard for broadcast-quality video cameras. And more.

The NEC difference...

Extensive use of LSI hybrid microcircuits developed uniquely by NEC makes the MNC-81A extremely stable in registration and performance, and ultra-reliable in circuit operation.

Low-profile and ultra-lightweight — camera head (without lens, but including 1.5" viewfinder) weighs less than 11 lbs. and measures approximately 10 $\frac{1}{4}$ " x 4" x 13 $\frac{1}{2}$ " — the MNC-81A handles with the ease of a compact 16mm newsfilm camera.

It is well balanced on the shoulder, with a form-fitting adjustable base. And its 1.5" viewfinder telescopes for convenient left or right eye viewing.

Best of all, the MNC-81A is a multi-purpose camera with the widest range of options for studio and field operation. Its sophisticated optional remote control

capabilities include a co-ax digital remote control system for distances up to 5000 feet, as well as fiber optics module and cable adapter for fiber optics video transmission from distances up to 9000 feet.

Quite a difference in operational flexibility and versatility compared to other cameras in its class!

The CP difference...

And, of course, when you buy an MNC-81A, you are automatically covered by Cinema Products' outstanding after-sales service and backup program.

You get an unprecedented full one-year warranty, with no service charge ever for warranty work! You get round-the-clock video service seven days a week. Replacement parts anywhere in the United States within 24 hours... And an easy-term lease/purchase program specifically tailored to your needs.

For complete details on the MNC-81A camera, contact Don Dunbar, Vice President/National Marketing. Call toll-free: 800-421-7468.

Distributed exclusively by:

cinema products
CORPORATION

Technology, In The Service Of Creativity

2037 Granville Avenue, Los Angeles, California 90025
Telephone: (213) 478-0711 • (213) 477-1971 • Telex: 69-1339

Bosch · TeleMation · Mach One · Bell & Howell - Fernseh

television product

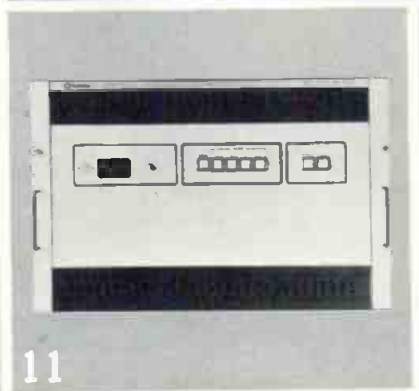
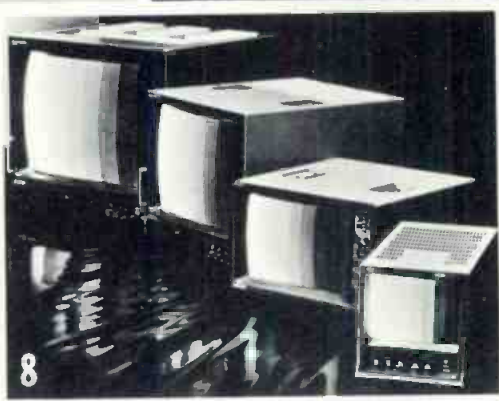
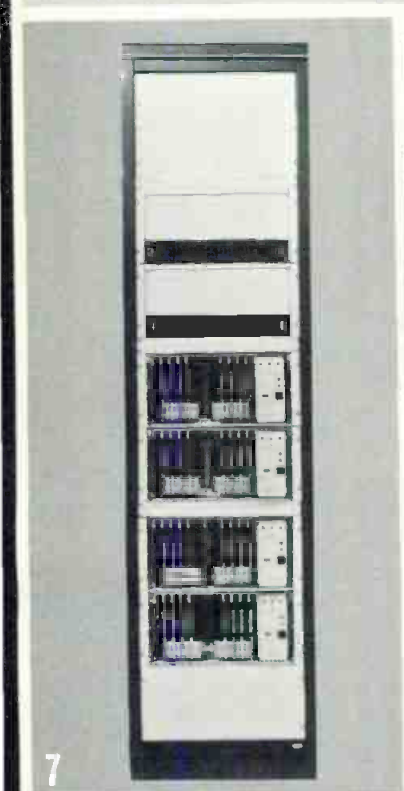
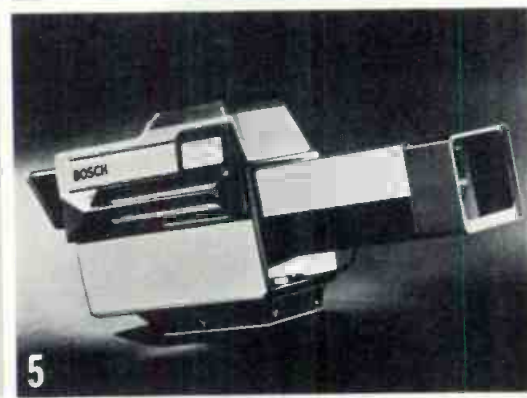

The most comprehensive family of products now offered to the broadcast industry.

TR's. Superb Bosch mechanical engineering provides 1-inch interchange and multi-generation performance that is unsurpassed. Shown (1 at left) are the reel-to-reel portable BCN-20, the reel-to-reel audio recorder BCN-51, and the world's first automatic multicassette machine with 16 hours of continuous playback: BCN-100. Also in the BCN family is the unique BCN-5, 18 lbs. lighter than any other 1-inch portable. (2)

Mach One™ Computer-Assisted Editor. By any comparison, Mach One's keyboard requires the absolute minimum number of keystrokes for all operations, which include special effects and auto assembly. Controls up to six VTR's. (3)

Cameras. A complete line including the new CA-100 ENG camera with state-of-the-art sensitivity, resolution, and signal-to-noise performance (4); the KCP-60 production camera with the optimum blend of high performance and low price (5), and the top of the line, fully automatic KCK. (6)

Distribution Switching. The TVS/TAS-1000 series, with the latest in alpha-numeric controls for easy, error-free operation, has set a standard around the world for compact design and reliability. Building-block matrix concept for configurations from 10 X 10 to 100 X 100 and beyond. (7)

Monitors. No less than twenty models, from 25-inch color to 9-inch monochrome; three performance/price classes; cabinet and rackmount; all color standards. (8)

Telecine. Fixed or variable slow motion speeds, forward and reverse, as well as fast motion up to 25 times normal speed is now possible with the revolutionary FDL-60 CCD Telecine. (9) And for the economy and input flexibility of vidicon film chains, the TCF-3000 Telecine Camera. (10)

Noise Reduction. Up to 18 dB signal-to-noise improvement, plus image enhancement and chroma-to-luminance delay correction with the TDF-2 Digital Noise Filter. (11)

Graphics Systems. The software-based Compositor I™, with full function dual channels, offers push-button access to over 100 font styles and the largest memory of any machine of its kind. (12)

For detailed information on the Fernseh family of products, including machine control systems, sync generators, optical multiplexers, processing amplifiers, color encoders, and a complete line of video, audio, and pulse distribution equipment, write or call Fernseh Inc., P.O. Box 15068, Salt Lake City, Utah 84115, (801) 972-8000.

*For literature only, call 1-(800)-821-7700, Ext. 701
In Missouri, call 1-(800)-892-7655, Ext. 701*

FERNSEH INC.

*the Video Corporation of
Bell & Howell and Robert Bosch*

CREATIVITY TAKES FLIGHT ON AMPEX VIDEO TAPE.



BROADCASTERS AND PRODUCTION COMPANIES DEPEND ON AMPEX TAPE.

From videotape equipment to the video tape itself, broadcasters and production companies throughout the world depend on Ampex. High quality, durability, reliability, and prompt service are just some of the reasons.

Ampex 175 Highband Quadruplex Video Tape has proven itself under every conceivable type of operating condition within every video standard. Excellent color performance, low drop-outs, and a tough durable formulation with low headwear are features which have contributed to this dependability.

And now Ampex 196 High Energy Broadcast Helical Video Tape has been specifically engineered to fill the increasing needs of a particularly demanding group of video professionals—those who have chosen one of the new broadcast helical VTRs.

No matter what your video tape needs are, there's an Ampex video tape for you. And, once you've tried Ampex tape, you'll see why broadcasters and production companies have grown to depend on Ampex.

AMPEX

REFLECTIONS OF REALITY. AND BEYOND.

Ampex Corporation, Magnetic Tape Division,
401 Broadway, Redwood City, CA 94063 415/367-4463

Circle 132 on Reader Service Card

RADIO ENG: IT'S A LUXURY NO LONGER



What was once "the fancy stuff" for a select few radio stations is becoming more and more of a necessity in today's highly competitive radio market. Radio ENG — keeping stations right on top of the communities they serve — is getting to be what today's listeners expect from their radio stations.

FOR RADIO BROADCASTERS, electronic news gathering is leaving behind the somewhat "fancy" character it had a few years ago and is becoming, in many market situations, a survival tool.

This hardening of character springs, of course, from the piling up of radio signals in large markets and small (Los Angeles, 83 radio signals; Seattle, 23; New York, over 100; Burnsville, N.C. — population 14,000 including the county — eight signals). With competition like that a radio station can get left behind if news coverage falls noticeably below the attraction level set by one or more other stations in the town.

We should resist the feeling that the radio audience is getting spoiled. They have in many markets learned to expect instant, credible, on-the-spot reports from every local event of any weight, with interviews and other "actualities" that give the reports veracity and human interest. Listeners are also getting used to personal help from discussions of economic and political forces that affect them.

A little consideration tells us that such close currency with the community and help in understanding social forces are not "luxuries" any more. The march of technology has made that kind of information service practically a citizen's due. The radio managements covered here, all doing outstanding ENG jobs, are in fact all proud of what they are doing for their respective communities. They have valid claims to being public servants.

But they all agree, too, that in their respective market situations ENG is now a basic tool of competition, one they would be badly off without.

ENG naturally comes in packages of different sizes. It can be done with a single vehicle that has high-grade two-way radio, or it may deploy a helicopter, 12 vehicles, a UHF repeater station, and a high-power walkie-talkie for every reporter. Each management must determine the

scale of the operation that will do the best job, considering the station's resources and the state of the competition. But if some station in a market is doing an all-out job of local coverage, a competitor cannot afford to demonstrate late responses to breaking news, inattention to community interests, second-hand material on the air, minimal credibility.

A broadcaster who has successfully staked out a special corner of the market may not need ENG. This works mainly in big cities; the classical station is an example. But even listeners who do tune in for specialized music they particularly want are unhappy without some minimum of regular local news coverage. The Associated Press study of radio listener attitudes to news brought this out. Beautiful Music listeners, for example, who had long been thought indifferent to news, put good local news coverage second in their ranking of things they want, right behind the music. The AP study, summarized in the March, 1979, issue of this magazine, is loaded with valuable guidance on the handling of news.

An ENG operation can improve a station's standing with the public simply by making the station visibly present at many city events, such as fires, bank robberies, inaugurations, exhibitions, award ceremonies, parades, or bank openings. An attractive vehicle and personable staff obviously doing a competent job are high on the list of station assets. Absolutely basic, though, is being on the air quickly with important local news, becoming, if possi-



The core of an ENG operation is a vehicle, like this one at WHDH, Boston, that has a radio link to the studios. The radio link should produce signals of broadcast quality, so they can be aired as received or recorded for later broadcast

When you care enough to receive the very best.

Farinon Video central receivers continue to gain acceptance by broadcasters who demand the very best in ENG reception.

From the Big Apple to the Golden Gate, from the Windy City to Big D—more and more TV stations including the flagships of the major nets are choosing our 2-GHz FV2CR Central Receiver because of its superior performance, flexibility and reliability. With 21 synthesized channels and an unsurpassed dynamic range, the FV2CR has minimized the problems of weak signals and distortion that in the past spelled disaster to ENG reception.

However, if the 2-GHz band in your area is over-

crowded or you're allocated different frequency spectrums, we offer two new and equally superior alternatives: Our FV2.5CR that operates from 2450 MHz to 2690 MHz, and our FV7CR that covers 6875 MHz to 7125 MHz. And, like the FV2CR, these truly state-of-the-art central receivers feature instantaneous phase-lock loop and fully synthesized channel selection. So now you can cover any and all frequency plans.

When you care enough to receive the very best, you need the very best ENG central receivers: Farinon Video's FV-CR series.

As a member of the Farinon Group of the Harris Corporation, Farinon Video is

an innovator of portable and mini-portable video transmission systems, STL and TSL microwave radios, FM transmission channel systems, as well as video baseband treatment units and ancillary equipment.

For more information, contact HARRIS CORPORATION, Farinon Video, 1680 Bayport Avenue, San Carlos, CA 94070; (415) 595-3500; Telex 34-8491. In Canada, 657 Orly Avenue, Dorval, PQ H9P 1G1; (514) 636-0974; Telex 05-82-1893.



HARRIS
COMMUNICATION AND
INFORMATION PROCESSING

Circle 133 on Reader Service Card

Radio ENG

ble, *the* source of the top news — taking the listener, whenever possible, directly to the scene. The stories that follow illustrate these points.

WABB, Mobile — ready for whatever happens

This long-established AM and FM operation on the Gulf Coast of Alabama uses a Top 40 format put together “at home,” but the management has also developed a local news and community service operation of outstanding quality. In the January, 1980, issue’s accounts of crisis responses by broadcasters, *BM/E* described the station’s performance when Hurricane David hit Mobile and nearly blew the city down.

The station lost its FM antenna and three of the four AM towers, but managed to keep on the air an AM signal that covered the city. With its signal still there, powered by emergency generators, WABB became a vital information lifeline, the only one left for a long period, aiding in the evacuation of thousands of people to safety, advising listeners on how to survive the storm and its aftermath, disseminating directions to listeners from city officials.

This great public service to the city was possible because the management had a complete emergency staff plan and emergency equipment, but also because the ENG crews were highly trained and well equipped for covering the city and getting news back in quickly. There are three vans completely equipped with UHF radio for linkage to the studio. In addition, the news crew has a supply of hand-held transceivers for getting material off the street, or out of buildings, and into the van for relay to the station.

Bernard Dittman, president and general manager, told *BM/E* that he could no longer do without his ENG crew as a means of getting instant coverage of the city. During the storm WABB could tell listeners about conditions in each section of the city, up to the minute. In non-crisis periods the ENG crew attends an enormous variety of events: the mayor speaks at the Coliseum; the city marathon is run, with a WABB car right behind the runners; a parade gets thousands of people onto the street, and the WABB vehicle, with the call letters emblazoned on its side, makes another appearance on stage. The operation is part of the essential structure on which the station’s success stands.

WHDH, extending studios throughout Boston

In Boston WHDH has a front position with its Adult Contemporary format, supplemented by a most extensive local news and public affairs operation. The equipment used includes a mobile studio in a van constructed by the engineering staff, with equipment that makes it a top-quality stereo originator (for WCOZ, the FM affiliate, and for AM stereo, if and when). WHDH can send out the van with the DJ and all materials and put on a regular program from any remote location in the city. This allows the DJ to make direct contact with the crowd at any kind of event, rousing their interest in and respect for the station and its programming.

Also in the ENG cabinet is a helicopter for traffic reports and other from-the-air-coverage, with UHF radio linkage to the studio; and 12 cars with the UHF radio links, plus hand-held transceivers that free the reporters to get material directly out of crowds, etc. A repeater in a high building improves the reach and reliability of the 450

MHz system.

Several reporters with radio-equipped vehicles are on the road during morning drive time to supplement the helicopter by investigating traffic conditions close-up; eyeball reports and actualities on accidents, for example, are important functions of these crews. Each car, of course, has a police scanner for help in keeping on top of road happenings.

The ENG cars, of course, take WHDH to all “set performances,” mayoral inaugurations, etc. If there is a community affair — a recent Muscular Dystrophy campaign is one of many examples — WHDH is very happy to “barter publicity for performance,” as chief engineer Paul Hurd put it to *BM/E*. The remote crew will tie the event to the station so that every necessary communications and publicity function is carried out, including reaching a very wide radio audience with the appeal.

Another kind of affair that WHDH is pleased to join in is, for example, an Air Force show at a nearby Air Force base, with the usual impressive mass fly-bys and stunts in the air. The WHDH helicopter can be “parked” on the air-base pad, and in the case of the Air Force show was seen by more than 200,000 people while getting a full account of the show, with all its sounds, back to the studio.

Another governmental “show” that WHDH supported fully with its ENG crew was an Energy Fair organized by the state’s lieutenant governor, with a display and a raft of impressive speakers in what was basically an educational operation. Putting the whole thing on the air extended the educational reach greatly, serving the state government well in a matter of extreme importance.

WHDH tries for actualities in as many of the local news reports as possible, and the ENG crews are well trained in choosing the subjects and getting them on tape. Equipment in the cars allows the recorded material to be sent to the studio via UHF for immediate airing; or the tapes can be brought in for editing and later use.

Again, the management of a very successful radio station frankly calls an expensive ENG operation one of the essential supports for the station’s market position.



In ENG vehicle used by KLAK/KPPL, 450 MHz radio for link to studio is in space to right of operator. Hand-held transceiver, lying on seat, can use car system as relay to get live material into the studio

Radio ENG



In KLAQ/KPPL newsroom, receiver for 450 MHz two way radio is on shelf, within easy reach of operator. He can put an incoming report on the air or record it on the cart machine, next to the receiver on the shelf

WHO, multi-state voice

From Des Moines, Iowa, 50 kW AM station WHO, one of the "clears," has been covering a large multi-state area with a mixture of music and lots of information for many years. In the last few years a good part of the information has been developed by ENG, and the management is now thoroughly committed to the idea that this is necessary to their stance in the market. The management also takes very seriously its responsibility as a clear-channel station, and emphasizes the public service opportunities in the ENG operation.

For morning and afternoon traffic reports, WHO uses a fixed-wing plane with UHF radio. Technical director Robert Engelhardt says that this plane has worked better for them than a helicopter used earlier. Traffic is high on the list for listeners in Des Moines because two interstate highways intersect in the center of the city. There is also heavy activity on several railroads going through the city, and grade crossings become serious obstacles to traffic flow from time to time.

The WHO air operation keeps motorists up on the grade crossings and other traffic hazards throughout the area. The aircraft, of course, are on the lookout for fires, local storms, and other events visible from the air that are important to the station's listeners. The airborne traffic reporters cover not only the drive times but also any special traffic situations at other times. Examples are football games at two universities, one 25 miles away and one 100 miles away. The UHF radio gets reports on the football crowd traffic back to the station, whence they go on the air to be heard over the whole area.

WHO emphasizes comprehensive weather reports, not only for city business and personal listeners but also for the very large skiing industry in nearby Minnesota. (See article on another page in this issue on radio weather reporting.)

The operation includes a fleet of ground vehicles using the 450 MHz radio to get live material into the studio.

WHO sends its crews to all events of importance in the city: this is the core of any ENG operation. Engelhardt pointed out to *BM/E* that they have lately found high RF power (at least 18 to 20 W) in the hand-held transceivers extremely useful in many situations: the units they have now are from GE. The moving reporter can get into the center of a large crowd, for example, and easily reach the van for relay back to the studio. The same rationale applies to reporters on the road, who may not be able to get the ENG car less than about a quarter of mile from an accident scene. The reporter can walk up and be on the spot for live coverage.

The WHO programming includes frequent telephone call-in shows, many kinds of information programs for farmers, MOR and Country music, "big band" music from a collection of recordings made in the station, in addition to the very complete news coverage. For farmers, WHO sends two staff farm experts to agricultural meetings and seminars all over the world. In some cases their reports back to the station are telephoned in from wherever they happen to be, and may be aired live, including actualities taped at the scene. This is, of course, a form of ENG. In many cases the reports and actualities are brought back on tape for later airing. Engelhardt noted that this very expensive coverage of farm conferences in many parts of the world, probably unique in American radio, is another evidence of the management's determination to serve its listeners on a high level.

KLAQ/KPPL, on top of happenings in Denver

Sister stations KLAQ-AM and KPPL-FM are both on popular music formats, KLAQ with Country and Western music, KPPL with Adult Contemporary. But the management has chosen to install a substantial ENG operation to stay competitive in the market and serve listeners better. There are several vehicles with 450 MHz radio, including two vans with elaborate program origination equipment. Any of the cars can be sent out for hard news — the fire downtown, the bank robbery. The stations maintain very close communications with the police department, city hall, and other spots where local events happen or are first recorded.

The UHF system gets a large range through an automatic repeater station on 11,000-foot Squaw Mountain. The remote vehicles can go anywhere for miles around and be strong at the studios. Handling of the news is flexible. KPPL puts local news on frequently during the day, with a one-minute update at five minutes after the hour and detailed coverage of local news at 30 minutes after the hour. Careful audience sampling has shown that listeners are used to this plan and expect it day by day.

KLAQ has the ABC Information Network and puts it on the top of the hour. During drive time, local gets a larger proportion of the time. Jerry Westerberg, chief engineer, said no station in that market can be in the higher part of the ratings if the news department simply repeats what it hears on the police scanner. For the Denver listener, the newsman must say, "I am there — I see it." In addition, the reporter must be on the scene early — first, if possible.

Ten, 50 other similar reports on radio's use of ENG could be assembled, if the time and space were invested. But these four accounts make all the main points. They show that the radio listener is benefiting in a fundamental way from the technology that makes ENG practical, and from the industry's ever increasing use of it. **BM/E**

When you're hot,
you're hot.

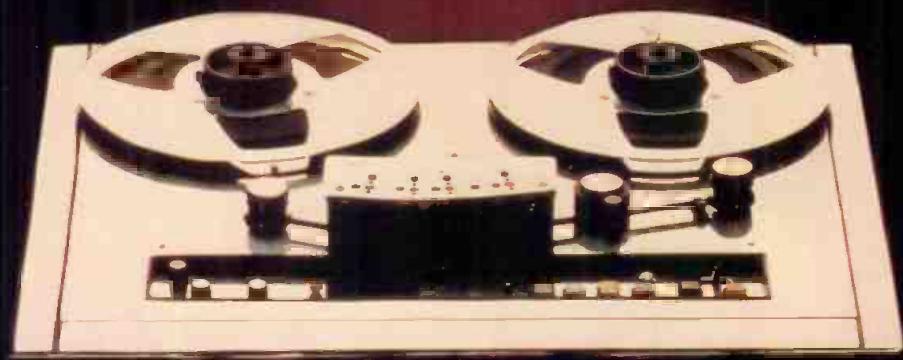

JH-110-B...the hottest

Sure, it's one of the most reasonably priced lines of tape recorders/reproducers in the industry, but don't buy the JH-110B just for the sake of economy. Buy it because it's the hottest tape recorder made today.

Just look at the standard features...timer/locator with four programmable memories plus return to zero function...readout in minutes and seconds or inches per second...three speeds plus variable speed... "plug in" ready wiring for interface to SMPTE/EBU synchronizer...touch sensitive manual velocity control.

Now think about how well and how easily the JH-110B works for you because of its overall design concepts...totally transformerless electronics for cleaner sound...plug-in modular circuitry for easy, inexpensive diagnosis and replacement of individual components...built-in accessibility for convenient maintenance and servicing...user-oriented design requiring minimal adjustments and alignment.

The JH-110B Series from MCI. Not one single line of professional recorders can provide all its standard features. Not one single line of professional recorders can offer all its design advantages. Not one single line of professional recorders can compete with its per dollar value.

In case you wondered, that's why we call the JH-110B the hottest tape recorder made today.

RTZ III.

Unlike any other recorder on the market today, the JH-110B comes standard with a built-in tape timer/locator with four programmable memories plus return to zero function. Reading out in real time, the RTZ III timer/locator can be used to accurately time spots or takes and to return to and automatically cue on zero or any of the other four memory

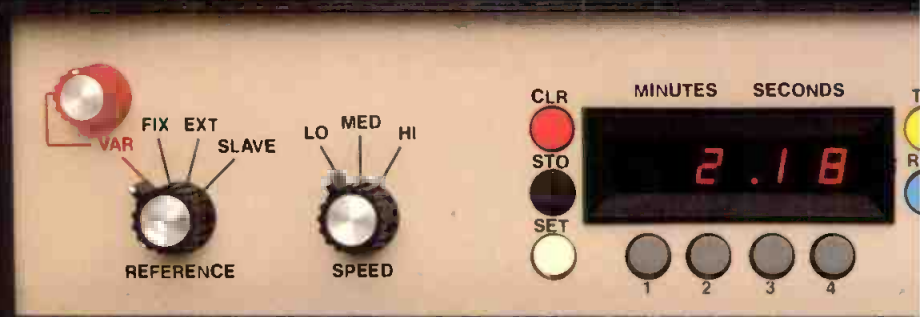

locations. Memories can be reprogrammed quickly and easily by manually "dialing" in the desired location or by loading from tape position in stop, play or wind modes.

The RTZ III also provides a tape velocity indicator (TVI) function offering an instantaneous and accurate readout of tape speed in IPS to two decimal places.

MANUAL VELOCITY CONTROL (MVC).

In addition to providing easy back and forth tape shuttling for one-hand cueing and editing, this touch activated "joystick" offers a way to protect your irreplaceable master tapes and expensive alignment tapes by limiting wind speed in rewind and fast forward modes.

Two edit modes are provided to meet your specific needs. In the "paper basket" edit mode, the edit button disposes of unwanted tape over the edge of the transport. In the "splicing" edit mode, the edit button disables reel tension and braking without attempting to take up slack tape. Using MCI's optional tape marker and scissors, edit marks can be placed exactly over the playback head for a precise 30° cut.

HEAD MOUNTING SYSTEM.

Completely unaffected by vibration or shock, the unique spring loaded



head mounting on the JH-110B offers ultra stable alignment for long term stability. Tape format changes can be made quickly and easily by lifting off the entire head assembly (only two

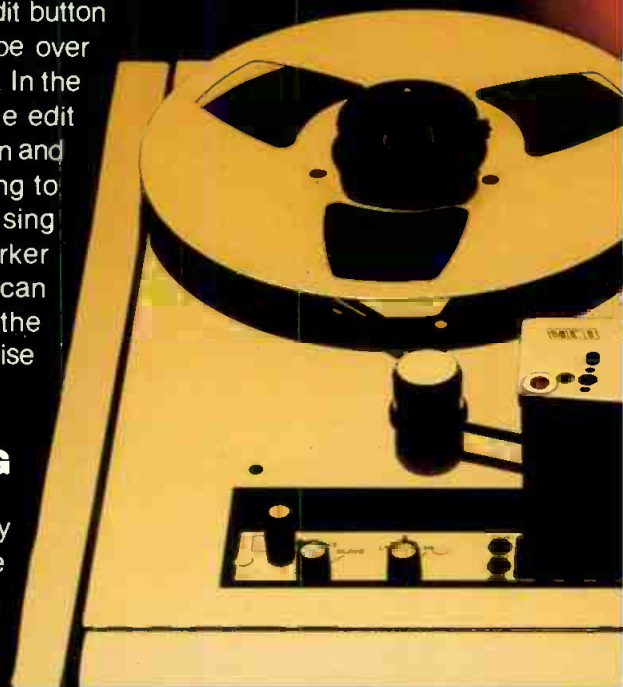

The chrome plated JH-110B is a special edition. Show item only.

ape recorder made.

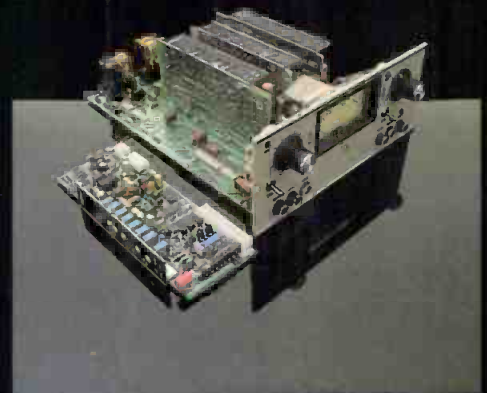
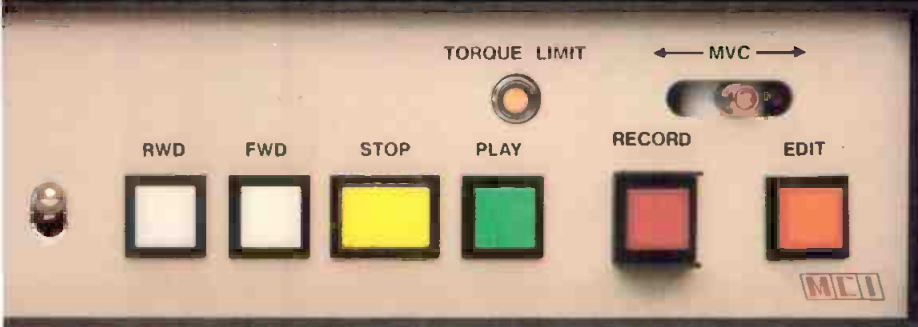

TRANSPORT.

Logically laid out in terms of function, the JH-110B transport features modular plug-in circuitry based on the "mother" board concept. Each transport printed circuit board is a separate subsystem for easy diagnosis of problems and quick, simple repair. Utilizing the same printed circuit boards as the MCI JH-24 Multi-track System to minimize your spare parts stock, the JH-110B transport features separate boards



to remove) and replacing the guides with comparable assemblies for the new format. A fourth head mounting is reserved for changing format heads to allow monitoring of 1/4 track stereo tapes on a professional 1/2 track format stereo recorder.

In addition to manually activated play and shield, the transport features a lifter defeat for high speed cueing. A scrape filter also is included on the head assemblies.

TAPE SPEED.

Designed with your need for flexibility in mind, the JH-110B features standard play speeds of 7 1/2, 15 and 30 IPS with speeds of 3 3/4, 7 1/2 and 15 IPS also

available. All three speeds are normally controlled by an on board crystal reference, but $\pm 20\%$ variable speed is provided. The transport can also be controlled by an external voltage or frequency source.

Built into the transport is all circuitry required for use as a synchronous slave with the MCI JH-45 AutoLock SMPTE/EBU synchronizer. Tape tension for all play and wind speeds is servo controlled and constant from tape end to end.

for the transport logic system, servo controlled analog torque system, servo controlled phase lock capstan drive system, indicator and interface functions and the various solenoid drivers. To simplify problem analysis, an optional annunciator board is available providing LED indications for all internal transport commands.

Alignments required are simple and



few -- left and right torque reference, phase lock and MVC sensitivity. No other routine maintenance or lubrication is required.

ELECTRONICS.

The fact that JH-110B electronics are totally transformerless means that you will notice significantly improved frequency response, signal-to-noise ratio, transient response, spurious RF rejection and hum rejection. Operational amplifier circuitry is used throughout and, with the exception of a fail safe relay for the record head, all switching is electronic. Because of MCI's exclusive QUIOR (quiet initiation of record) design feature, record punch in/out is noiseless, nonoverlapping and gap free. Remote record activation lines are provided for computer controlled editing systems.

Front panel controls are provided for repro, input or cue (synchronous) monitoring, safe and record ready functions and bias level monitoring. LED's indicate record ready, record and the equalization selected. Level controls for both repro and record include calibrate switches to select an internally presettable level. Illuminated VU



meters on each channel follow the selected monitor source.

Internal controls are provided for repro and record calibrated levels, repro high and low frequency equalizers, record equalizers and bias controls for each speed. NAB/IEC switching is independently provided for repro and record functions with no additional realignment required.

All electronics circuitry is mounted in pull-out drawer assemblies for easy access, with two channels to a drawer. Separate plug-in circuit boards are provided for repro, record, bias/erase and input/output buffering functions.

Transformers are optional on inputs and/or outputs for use where earth free or total DC isolation is required. The power supply is also modular with all active circuitry accessible either through the front access panel or rear mounted plug-in chimney/heat sink assembly. 110VAC/240VAC 50Hz/60Hz operation can be selected by the simple rotation of a plug/socket assembly and replacement of the mains fuse.

JH-110B Dimensional Data

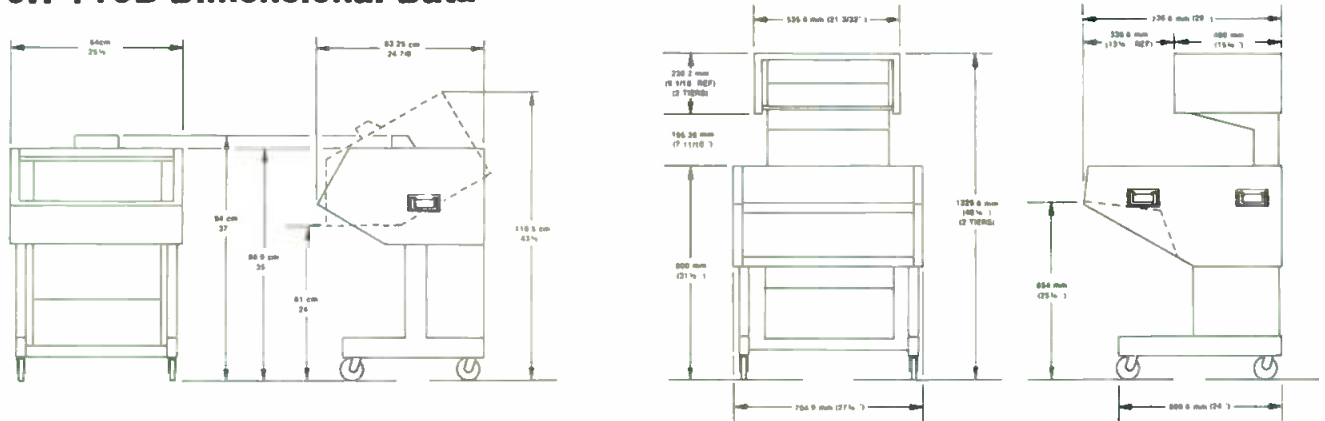

FLEXIBILITY TO MEET YOUR NEEDS.

The JH-110B is available stock in mono, stereo, 4-track and 8-track formats for use with 1/4", 1/2" and 1" tape on reels from 5" up to 10 1/2" in diameter (14" diameter optional). Ready for mounting in the MCI variable profile (VP) cabinet with electronics under the transport or in the MCI high profile (HP) cabinet with electronics over the transport, it can also be mounted in your 19" rack or custom console. An optional accessory allows full remote control of stop, play, record, wind, lifter defeat, manual velocity control and return to zero functions.



1400 West Commercial Boulevard, Fort Lauderdale, Florida 33309 USA.
Telephone: (305) 491-0825. Telex: 514362 MCI FTL.

MCI reserves the right to make changes at any time without notice in colors, equipment, specifications, prices and models.
© 1980 MCI All rights reserved. Litho in USA

MCI-81SB-3

ALL-NEWS TELEVISION DEBUTS AT KAUT

By Ron Hudson

KAUT-TV, Oklahoma City, is currently the only commercial broadcaster in the country to devote significant parts of its broadcast day to news, news, and nothing but news. The gutsy experiment is not without pitfalls, but management thinks it can succeed with an innovative approach to local programming.

IT COULD HAVE BEEN a worse day to start. The news was promising release of the American hostages in Iran, one of Oklahoma City's two daily newspapers printed its last issue and closed its doors, it was the eve of the presidential election, and cries of grand larceny were still flying after local fighter Sean O'Grady lost the title bid in Scotland. Armed with this ammunition, a brand-new TV station went on the air in Oklahoma City with an aggressive and innovative five-hour continuous daily newscast.

Each weekday, KAUT-TV, a Golden West station, signs on with news programming that continues until 5:00 p.m. Syndicated programming runs until 7:00, when the station changes to an STV mode and with a scrambled signal broadcasts movies and entertainment until 2:00 AM. KAUT'S subscription programming is operated by VideoEnterprises Unlimited (VEU), a Golden West division.

The decision to take the combination all news/STV approach was not an easy one, but several factors combined to favor it. For one thing, when Jerry Birdwell, Ch. 43's vice president and general manager, looked at the Oklahoma City market rating books, he found a jump in viewers at newscast time. Also, KAUT would be signing on as the market's seventh station. This meant that Birdwell would not have a buyer's market for syndicated shows, the usual non-pay fare for STVs. These factors may have made the decision easier to make, but there is still a world of difference between proposing a new con-

Ron Hudson has worked in a variety of broadcast news positions. He is currently marketing director for News-can.



KAUT's all-news format, Newswatch 43, is broadcast from its newsroom from noon until five p.m.

cept on paper and making it work. Ch. 43's programming is a bold step with plenty of pitfalls.

KAUT's format is currently the only one of its type, but the idea has been tried before. In the early 1970s, KMEX-TV, a Los Angeles Spanish-language station, tried the all-news approach with a part-time English-language format. It fell flat and was cancelled after only five months. Birdwell says there are several reasons why KAUT will not suffer the same fate.

First of all, he argues, KAUT has a larger staff and live and ENG capability, which KMEX did not. With film, the immediacy that is possible with today's technology was just not available. Birdwell further says that today's viewer is more eager than ever before for news. With programs such as *60 Minutes* leading the way, news has become a viable programming tool.

Local emphasis is strong

Birdwell is extremely interested in Cable News Net-

All-News At KAUT

work and is closely watching how well it is received, but he also says there are major differences between CNN and KAUT. "CNN has no local market, and that's our major emphasis. But like CNN, we have the ability to expand on a story — give it more attention than is possible with a half-hour newscast, which because of time limitations really has to be a headline service."

KAUT will be operating with a much smaller investment than CNN in both time and people. The station's original press releases promised a 9:00 a.m. to 5:00 p.m. news block, but before air time it was decided to start with a more conservative noon-to-5:00 schedule. This is expected to continue until after the February/March rating book, when an extensive evaluation will determine if expansion is warranted and how much.

Birdwell says he's getting some surprises from viewers who want the station to extend the hours. "The bulk of the requests are for later hours rather than earlier. We end our news programming now at 5:00 p.m. because there are other local news programs on after that and we did not want to compete with them. But based on what we know now, that may be what happens."

Chris Davala is KAUT's news and public affairs director. Most recently he was assistant news director at an all-news Oklahoma City radio station, KTOK. While he has no television experience, Davala does have extensive experience in radio, and both he and general manager Birdwell say they feel the radio background will be a plus factor for Davala, since there is no tendency for him to

think in 6:00 and 10:00 p.m. deadlines, as might be the case for someone with an exclusively television background.

KAUT's news department, with a staff of 23, is the smallest in the Oklahoma City market. Davala says, however, that he's doing more news with less staff. "Our news is slower-paced than the other news programs and more informal, which causes less strain on the anchor people. With the people we have in the field feeding stories to them and the ability to stop and discuss things, we are finding that newscasting can be a lot of fun."

Perhaps the greatest problem with a several-hour newscast is maintaining a pace that will keep viewers. A station with a traditional half-hour or hour newscast has a difficult enough time keeping up the excitement and the viewer interest for the full time day after day. KAUT's management thinks it has the right combination of people and news sources to do the job.

Anchors: controversial, competent

The newscast anchoring is primarily by Ralph Combes and Linda Farrell. Both have worked at other stations in the market, and each sparked controversy in leaving former jobs. Combes is well-remembered by Oklahoma City viewers, having worked twice in the market before. Prior to a call from Davala, Combes had been out of broadcasting for four years, something he says was caused by his having been labeled "controversial" and a "troublemaker."

In 1975 Combes was fired as anchorman of Oklahoma City station KWTW. He went to court alleging that his termination was based on his age (he was 49 at the time)

SMPTE EDIT-CODE READER AND CHARACTER-GENERATOR



THE NEW STANDARD OF THE INDUSTRY

FEATURES: The McFadin Window™ wide range digital decoder, highly legible and unique FONT, 1-3/4" rack mounting, vertical interval display, all front panel controls, drop frame indicator, choice of Time-Code or User-Bits, regenerated Time-Code output (DUB). MODEL DR-107A



504 W. Chapman Ave.
Orange, Ca. 92663 714-997-4151

Circle 135 on Reader Service Card

MINIATURE CONNECTORS

Specify Lemo where connector size is the important consideration. Both coax and multicontact types are available.

Superb design and workmanship, ease of connection and disconnection, and ruggedness make Lemo

the front panel connector.



(Actual Size)



P.O. BOX 6626, SANTA ROSA, CA 95401 • 707/523-0600

Circle 136 on Reader Service Card

and that he was the victim of age discrimination. He won the suit but not reinstatement in his job, and later he found that every news director he talked to about a job had heard of his lawsuit. Davala says he has no interest with any problems Combes may have had in the past. Instead, he's certain he has a solid journalist.

Combes' co-anchor is Linda Farrell, who had worked with Davala before at KTOK radio. When KOKH-TV, a Blair-owned Oklahoma independent, went on the air in late 1979, she signed on as news director, but less than a year later she resigned that position with the local press quoting her as being "bored, frustrated, and disillusioned" with the station's attitude toward news. The KOKH newscasts were half-hourly three-minute inserts when the station signed on, but a series of time cuts now have the newscasts down to 30 seconds each. One *Daily Oklahoman* story said she was "not bitter," but also quoted her as saying the cuts recommended by the Magid consulting firm had resulted in a headline service and "You could get an ape to do that."

Typically, each hour begins with news director Davala giving a summary of the top news stories at the time, then either Combes or Farrell, who alternate at the anchor desk, taking over for the rest of the hour. The format stresses flexibility, and Davala or another of the news staff may pop in at any time with an expansion or comment about a story.

KAUT has three remote units for area coverage. One has four-camera live capability and is equipped with a special effects switcher. A second also has live capability with one or two cameras. The third serves as backup, with one camera and recorders. The remote units with live capability have air-mast 40-foot transmitting antennas, and the signal is received at the station on an antenna 1500 feet up on the tower. Birdwell says that this gives the station live coverage ability within approximately a 50-mile radius.

To supplement the input from the local staff, KAUT has arrangements with CNN and NIWS for national and international news stories, feature material and special reports, and is negotiating with ITNA for its service after the first of the year. All of Golden West's VEU programming is to originate from the Oklahoma City facility, so the station is equipped with a Scientific-Atlanta 10-meter satellite up-link in addition to a seven-meter receiver. This send and receive capability may be at least part of the reason why the station's management was able to wrap up reciprocal agreements with so many independent news sources.

Combatting viewer confusion

One problem that station management anticipated is some level of viewer confusion due to the mixture of free and pay programming. Extensive outside advertising and promotion has been used to try to entice viewers to try the all-news programming, and during the STV portion of the day, viewers without scramblers hear an endless audio promo advising them of the free daytime fare and an explanation of the subscription service.

At least some of the viewer confusion may be eliminated because of another station's problem in getting on the air. Trinity Broadcasting's Ch. 52 has had to postpone its sign-on with full-time religious programming while some technical problems are being worked out. Trinity had programming lined up which it was unable to show, but KAUT quickly jumped at the chance to air some of the shows in the morning. The hope is that viewers who watch



Anchorman Ralph Combes returned to television after a four-year absence to take part in the KAUT all-news experiment



KAUT's news director, Chris Davala, also does some on-air reporting. He is shown here with the other regular anchor, Linda Farrell

in the morning will keep watching and become hooked in the afternoon.

It will be some time before all the answers are in. Golden West says its studies of the Oklahoma City market show that viewers like their news, so it is optimistic about the success of the local all-news concept. But Oklahoma City was essentially a three-station market until late 1979. Since then, two independents have signed on and cable installers have been busy. What the studies may have shown is that Oklahoma City viewers like their news when news is all that's available. KAUT is competing head-to-head with the soaps, game shows and movies, and not with a competitor's newscast. Birdwell says this represents a rather unique approach to counter-programming, with news being offered as an alternative to entertainment, and he's confident that it will work.

One thing is certain. If KAUT does prove that the concept will work, the title "the only station of its type in the nation" won't apply for very long. **BM/E**

If we had set out to give you only
the features our competition gives you,
this is where we'd be today.



Most VTR units give you only a fraction of the features you might want from a video tape recorder. So we didn't stop where our competition did. We kept on adding features. Until we developed the most versatile 1" machine on the market.

Compare the 3M TT-7000 VTR and NTC-10 Time Base Corrector to the competition. Nobody puts together more of the features you want than 3M. And once you see our unit, we think you'll agree that buying anything else is like getting half a machine.

The 3M TT-7000 Video Tape Recorder gives you:

- Auto track following (ATF) ¼ reverse through 2x forward (optional).
- Video and sync confidence heads.
- Three channel audio confidence heads.
- Video sync channel.
- All DC motor and servo tape transport.
- 19" rack mountable with full dust cover.
- Front panel plug-in modules.
- Frame accurate insert and assemble editing.
- Dual tape timer with zero memory.
- Tape speed override on front panel.
- Stop tone and cue-up (0, 3, 5, 7 sec. preroll).
- Contact closure and TTL external interface.
- Variable speed forward/reverse shuttle.
- Still frame jog.
- Autochroma and color framing.
- Audio 3 record in play mode (built-in speaker).
- Instant stop action from play or slo-mo (with ATF option).
- Instant audio bias level adjust.
- Video level calibrate marker.
- Preset/Manual tracking select on front panel.
- Fixed precision rabbited drum tape guide.
- And low RF, high temperature and low voltage alarms.

Our Time Base Corrector comes complete with its own list of standard features:

- Sixteen line correction window.
- Ten bit quantizing.
- Four times subcarrier sampling.
- 65 dB signal-to-noise ratio.
- Velocity compensation.
- Digital one line drop out compensator.
- Compact size (8¾" high by 17½" deep by 18½" wide).
- 45 pounds total weight.
- Portable cabinet or rack mountable.
- And front panel plug-in modules.

Add it all up, and you've got the most complete VTR/TBC package on the market. For a free

demonstration, call (612) 733-7914 or write 3M/Mincom Division-Video Products, 223-5E 3M Center, St. Paul, MN 55144.

In Canada contact 3M Canada, Inc., P.O. Box 5757, London, Ontario, N6A-4T1.

In Alaska contact 3M Company, 5331 Minnesota Drive, Anchorage, AK 99502.

Get the complete picture.



3M

Make news with our lightweight new TK-86. It's a worthy successor to RCA's trusty TK-76, the ENG/EFP veteran that's served beyond the call of duty on newsfronts around the world. Through hell and high water.

It has the same basic electronics as the celebrated TK-76, but uses 33% less power. And there's the same ruggedness, reliability and serviceability. But shoulder the TK-86, and feel the difference.

With its form-fitting base, it nestles comfortably and securely on the shoulder. It's nicely balanced. And it can remain conveniently upright when you set it down.

It has an improved optical system, with a totally-sealed f/1.4 beam splitter. It's available with low-capacitance versions of the Saticon® or Plumbicon® tubes. And with a full range of remote control devices. Of course, it's backed by incom-

parable RCA Tech-Alert service. See your RCA Representative. RCA Broadcast Systems, Building 2-2, Camden, NJ 08102.

NEWEST NEWSMAKER.



Can you really
afford less?

ENG/EJ: A SERIES OF NEW POSSIBILITIES

The advent of ENG/EJ has helped ease the frustration of news departments over shooting ratios that kept specials and series to a minimum and confined them to rating periods.

WOR-TV, CH. 9, MAY BE in the nation's largest market — New York City — but in many respects its news department is like that of a much smaller station. The staff is small and the budget is tight. But the station was the first in New York to go all-ENG. The reasons were, according to sources, mostly economic, but the change has spawned some informational programming that didn't exist before. The news department produces two weekly half-hour magazine shows outside its normal news blocks.

Nine on New Jersey features stories about people and events in that state. (All the New York stations have been under attack for years by many Jerseyites for what is seen as their failure to provide more coverage of events and news in New Jersey, which does not have a VHF outlet.) *The Apple Polishers* is a collection of profiles of people who have done something positive for the people of New York City.

ENG makes it possible

Neither show could have existed on the station before ENG. The amount of film involved in producing the broadcasts would have been prohibitive. Add in processing, editing, and time for dealing with each, and the cost continues to mount. If the shows were done on film it would also be necessary to have a special unit which did nothing but those broadcasts. As it is, the reporters in the news department shoot and edit the individual pieces. The whole thing is then tied together with leads and bridges featuring the shows' hosts. In the case of *Nine on New Jersey* the host is Herb Jaffe, a reporter for the Newark



WISH-TV co-anchor Carol Krause discusses her half-hour special on breast cancer with technician Al Szalay and director Ralph Jarrett

IN THIS BUSINESS IT PAYS TO BE SENSITIVE.

The new Canon J13x9B is the ideal lens system for every situation.

For example, when you're covering an impromptu interview in a poorly lit hallway. Or a nighttime fire. Or a crime scene. Or when the weather itself is so bad that it's news. These and hundreds of low-light situations call for a sensitive lens. That's why the zoom on the business end of your ENG camera should be a Canon J13x9B. At f/1.6, it's the most sensitive in its class. And the rest of its specs are impressive, too. Like its 13-time zoom ratio from a wide 9mm

to 118mm. Its built-in fluorite element for more accurate color correction. And its minimum object distance as short as 0.8m (31.5"). The lightweight J13x9B is available with a money-saving modular accessory package, giving you all the flexibility you need in the studio or field—now and in the future.

Specify the Canon J13x9B when you order your new ENG camera.

It's the perfect lens system for all types of field production, including news, documentaries, sports or any portable application. Because we're always sensitive to your needs.

Canon®

Canon U.S.A. Head Office: One Canon Plaza, Lake Success, N.Y. 11042 (516) 488-6700 • 140 Industrial Drive, Elmhurst, IL 60126 (312) 833-3070
123 Paularino Avenue East, Costa Mesa, CA 92626 (714) 979-6000
Canon Optics & Business Machines, Canada, Ltd., 3245 American Drive, Mississauga, Ontario L4V 1B8, Canada
Canon Amsterdam N.V., Industrial Products Division De Boelelaan 8, Amsterdam, Netherlands



NOW
WITH BUILT-IN
2X EXTENDER!

Circle 139 on Reader Service Card

www.americanradiohistory.com

ENG/EJ: New Possibilities

Star-Ledger. The paper's newsroom is the set for those segments featuring Jaffe. *The Apple Polishers* is hosted by the station's anchorman, Tom Dunn. Since the post-production on both shows is minimal, it is easy to see why they can be scheduled weekly with little fear of not making air. And since the tapes are reusable, it is easy to see why station management likes the cost factors.

While the WOR experience is not unique and is repeated in a number of markets, the more usual use of ENG/EJ technology is to expand the kinds of things that can be done within the context of the daily newscasts. "It's amazing what you can do," says Lee Giles, news director at WISH-TV in Indianapolis, "as opposed to the barriers you used to have with film." Giles goes on to tell about one of his creative uses of ENG — what he calls "no big deal."

Indianapolis, as with a number of American cities, has several professional sports teams which play out of the same facility. The sports director, Josh Lippman, thought it would be interesting to show what it took to change the configuration of the arena from hockey to basketball. Lippman and a photographer spent six hours one night following a hockey game and shot everything that took place as the arena crew took up the ice and put down the basketball court. They then went back to the station and spent 10 to 20 hours editing the six hours of tape into a piece that ran one minute and 12 seconds. The story began with tape of the hockey game as it ended and wound up with the beginning of the basketball game the next day. The whole thing was cut to music. "We never would have been able to do that on film," adds Giles, "because of the cost and the editing difficulties." Even with the extra tapes involved in a project like this the cost still stays low



Krause puts the finishing touches on the script for the cancer special, flanked by a stack of tapes that can be put back into service after the show airs



In addition to numerous prime-time specials, WISH does a 45-minute late news show. ENG technology played a part in easing the expansion

because the tapes can be put back into service time and time again.

This rotating pool of tapes allows WISH to do numerous prime-time news specials. There is no doubt in Lee Giles's mind that most of them could not be done without ENG.

Down the street from Giles's station is WRTV. Bob Gamble is the news director at the station. He and Giles are friends and long-time rivals. Gamble has been news director at WRTV for 21 years; Giles has been at WISH for 17. This longevity gives both men a perspective and perception that carries added weight. Both are old-fashioned journalists who also feel that state-of-the-art ENG/EJ can add much to the day-to-day news coverage. "ENG brings a new dimension to news coverage . . . and as far as I'm concerned, film is prehistoric," says Gamble.

Multipart series are a staple of news departments during rating periods. That hasn't changed, but now more and more stations are doing series on a regular basis year round. ENG/EJ has added greatly to that capability.

Series: all year round

Joe Rovitto is news director at WTAE-TV, Pittsburgh: "Our philosophy is to do series on a consistent basis, rather than just during rating periods." Rovitto believes that philosophy would be much more difficult to implement without ENG technology. As an aid to that end, the station has invested in more elaborate equipment for the news department's post-production effort. "The new Convergence editing system allows us to do freeze frames, dissolves, and other neat things right in the edit booth," Rovitto boasts. This will cause even daily news pieces to have that something extra that takes a routine piece beyond the ordinary.

WRTV recently aired a five-part investigative series on nursing home abuses. Gamble won't say that the series

**BET YOU NEVER
THOUGHT YOU'D SEE
YOUR GRANDMOTHER
STONED.**



Are Indianapolis nursing homes drugging patients to keep them quiet? Beginning tonight, investigative reporter Sam Wyatt looks at this and other charges of nursing home abuses in a special five-part series.

**CLOSE-UP: NURSING HOMES:
PRESCRIPTION FOR NEGLIGENCE?**

THIS WEEK AT 5PM.

THE NEWS



**AIR TRAFFIC CONTROLLERS
DON'T MAKE
SMALL MISTAKES.**



It's the ultimate in high pressure. Air traffic control. With hundreds of lives in the balance, even a small mistake can be deadly. How do controllers stand up under the pressure to be perfect? Marilyn Mitel reports.



**CLOSE-UP: AIR TRAFFIC CONTROLLERS:
A HIGH PRESSURE GROUP**

MONDAY & TUESDAY 10PM

THE NEWS



With stations doing more and more series, promotion becomes important in attracting viewers. Newspaper ads and even radio promos are used to increase awareness

couldn't have been done without ENG, but he comments, "we spent months on it and . . . tape made the editing and fine [production] details easier." Giles adds another reason why there are more series on the air: "The psychological effect on reporters has been removed from them to save film." This means that interviews tend to run longer, making more good information available. More time is needed to get all the information in, which leads naturally to more multi-parters.

WOR-TV reporter Judy Thomas reinforces that point. "You don't feel guilty anymore about overshooting because you know the tapes are reusable," Thomas remarks. "And what's really wonderful is when you run across a good interview, you know no one is going to ask you back at the station why you shot 400 feet of film on a 200-foot interview. You get a chance to use the tape on another piece later. And if not, nothing is wasted because the tapes can go back into service without costing any more money."

Tape library makes the difference

Expanded use of file material is another benefit of ENG/EJ. Giles: "We use a lot of file tape." Rovitto: "We use file tape all the time." Gamble: "There isn't a newscast that goes by without the use of file tape."

A good tape library can make all the difference in not only the voice-over use of material but in building whole pieces. When Jane Van Ryan covered the energy beat for WDVM-TV in Washington, D.C., a lot of people in the oil business would leak her information but would not say it

on camera. Even when someone would talk on camera, it was done in energy jargon which constantly had to be explained to the audience (in the oil business, downstream has nothing to do with an effect on the production switcher). The trick for Van Ryan was how to visualize the information gathered and explain the double talk. "There were many times," says Van Ryan, "when the only new thing that was shot was my standby in front of the pumps at the gas station up the street." She contends that if it weren't for the file tape, many stories just would not have gotten on the air.

According to WJBK's Mike Von Ende, "how many times can you cut up the same piece of film before there is nothing left — that is, if you can find the film?" Adds Giles, "And with our Sony benches there isn't the problem of generational loss."

As noted above, many stations are expanding into prime time news specials. Multi-parters can be re-edited into half-hour programs without much trouble. For the most part, additional visual material is available on the field cassettes. Animation, bumpers, and bridges are easy to put in with current graphic techniques and effect switchers. For little added cost the station has a multi-part series for the 6:00 and 11:00 news, and then a half-hour prime time special.

Quality news and informational programming that is locally produced brings not only prestige to a station but also additional revenues. And when a department becomes a profit center, it is in the position to expect kind treatment during budget negotiations. **BM/E**



**IF YOU'RE GOING TO DO IT ...
DO IT RIGHT!**

... "do it right" when designing and constructing mobile and
... ed television facilities to insure superior technical/mechanical
... rformance and human comfort.

... ellence in Telecommunication Systems Design and Engineering.

Circle 140 on Reader Service Card



COMMUNICATION ENGINEERS
San Diego, California • (714) 560-1575

ANYONE CAN MAKE ONLY SHARP MAKES



Introducing the Sharp XC-700. The first fully loaded prism camera for under \$12,000.*

It's got one of the best optical systems around. Prism optics (F/1.4)

to help you make the best use of available light. Even at night.

And an automatic beam optimization circuit. Because "comet tailing" is great for shooting comets,

A LOT OF CAMERAS. A LOT OF CAMERA.

but not the 6 o'clock news. Then there's some of the most innovative human engineering you've ever seen.

Because it was designed by the people who use the camera. Not the people who built it.

And to make ENG a breeze, you get Auto White Balance with memory. So whether you're indoors or out, the camera can be automatically adjusted for the changes.

And there's more. H and V enhancement to give you the sharp detailing that makes a documentary an eye-opener.

An attached battery that lets the camera wear the battery pack instead of you. There's Gen Lock.

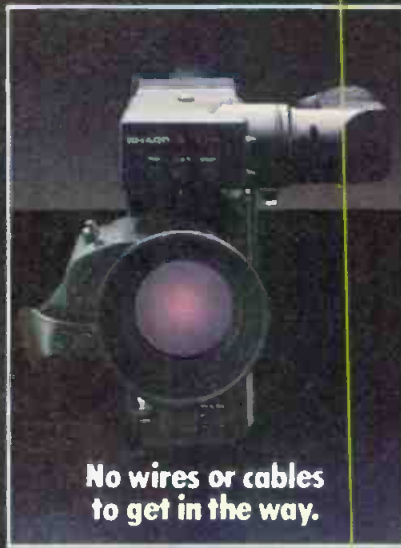

No wires or cables to get in the way.

I and Q encoder. Zebra pattern. Color Bars. An optional 7" studio viewfinder with underscan and a remote operations panel.

Now that's a lot of camera.

And if that's what you need to cover the elections this year or that sales meeting next month, see the Sharp XC-700.

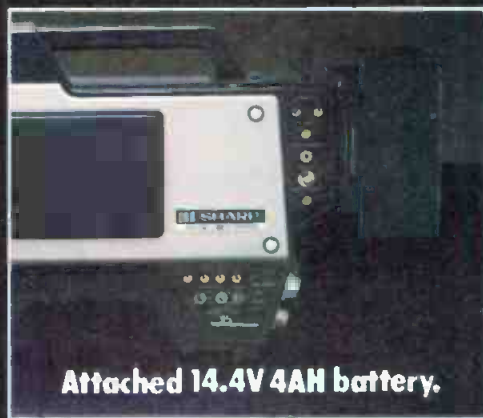

Attached 14.4V 4AH battery.

To have it all demonstrated to you, call your Sharp dealer, or in Los Angeles, call Ron Colgan at (213) 830-4470, in Atlanta, call Jim Freeman at (404) 448-5230, in Paramus, NJ, call Bob McNeill (201) 265-5548, or write us at Sharp Electronics Corp.,

10 Keystone Place,
Paramus, NJ 07652



*Manufacturer's suggested retail price less lens.

A NOT-SO-BASIC SYNCHRONIZER/TBC AT A VERY BASIC PRICE.

The Quantel DFS 1550.

It costs less than any other digital synchronizer on the market. Yet has features that make it unique in its class.

Of course it can synchronize any non-synchronous video signal. It also does a superb job of time base correcting, from phased or non-phased sources. With exclusive automatic non-phased detection.

And it has many other features, including an infinite window of correction, remote TBC capability, wrong-field edit correction, look-ahead velocity compensator, sync generator, 3.58 MHz feedback, and an analyzer for detecting faulty store cards.

In short, everything you need for digital synchronizing and time base correcting. And more than you can get from any other digital synchronizer or TBC at anywhere near the price.

If you are thinking about buying time base correctors, shouldn't you get synchronizing and TBC capability? The cost will be about the same—but the Quantel DFS 1550 will give you vastly greater performance.

Call your nearest MCI/Quantel representative for more details. Or get in touch with us directly: Micro Consultants, Inc., P.O. Box 50810, Palo Alto, California 94303, 415/856-6226.

MCI/QUANTEL
The digital video people



Circle 142 on Reader Service Card

"MCI/Quantel" is a trademark of Micro Consultants, Inc.

www.americanradiohistory.com

AIRBORNE REPEATERS: A MODEST PROPOSAL



Whenever and wherever a major news event takes place, there's a good chance a news chopper will be on the scene. But more often than not, the pictures coming back are shot at great distances, leaving a lot to the imagination of viewers. Relay options are an underutilized potential that can bring viewers up close to the action.

WHEN NEWS CHOPPERS first got off the ground a few years back, stations were quick to set up complex shoots in order to demonstrate for their audiences the importance of this news gathering system. But as the airborne microwave system has become accepted, one of its most valuable potentials has drifted into a fallback position. Repeater capability now is often a last resort and not routinely exploited in order to bring viewers the best possible news pictures.

There are a lot of reasons for this dilemma, but the state of the art argues convincingly that stations ought to be using the repeater capacity more frequently. In theory, a properly equipped helicopter would contain both transmit and receive microwave radios and antennas. Also, aboard the chopper should be a portable microwave uplink that could be landed near the scene along with a camera operator and possibly a technician. The chopper could then ascend to an appropriate altitude and begin relaying signals from the ground crew back to the station. Simple, right?

Wrong. It's not that simple. In urban areas, for instance, landing a helicopter is not that easy. Even in areas where surrounding buildings are not a problem, weather conditions, terrain problems, or combinations of both can prevent an airborne unit from landing.

There are other problems as well. Sometimes the terrestrial vantage point is inferior to the aerial. At other times, the ideal situation would call for both a terrestrial vantage point and an airborne vantage point. This can lead to carrying one heck of a lot of equipment in the cramped quarters of a helicopter cabin.

So, with all this standing in the way of airborne use, why bother? The answer: To get better pictures.

Using the repeater now

As most stations currently use the repeater systems,

they are relied upon as a last resort. When topography presents a ground-based crew with a blind spot where the receive antenna ought to be, up goes the chopper, if a convenient relay installation won't do. If the news crew is covering an event too far from the base station for single-hop reception, the chopper is frequently interposed as a mobile relay station. Both of these uses are worthwhile and commonly practiced.

On those occasions when the chopper presents itself as the way around a blind spot, the crew on the scene has generally arrived by van or sedan equipped with its own microwave gear. The chopper is dispatched only after the crew has determined that there is a blind spot or if the location is known to present such a problem.

It is at times when both a land-based crew and an airborne crew are on the scene that ENG microwave systems are capable of unparalleled coverage. In such instances a two-camera shoot can be switched if the helicopter is properly equipped. There are, of course, times when such tandem coverage is in response to the magnitude of the event and not a function of some impediment to microwave reception. Nevertheless, this type of commitment does represent an enormous dedication of station resources, so it is not resorted to unless clearly demanded by the circumstances. Few news directors would dream of routinely assigning both airborne and land-based ENG crews when one or the other could perform adequately.

But "adequacy" is a very subjective term. Too fre-

Demonstrating their new airborne system at RTNDA, MIA was able to get clear shots back to Hollywood, Fla., from the Bahamas. New linearly polarized omni-directional antenna provides 6 dB gain (inset)



Airborne Repeaters

quently the airborne camera position just can't get close enough to deliver meaningful pictures. At other times the action can be obscured by smoke or ground cover. Finally, the presence of several ENG choppers can present hazardous flying conditions as several birds maneuver for position. The industry hasn't had its first mid-air collision yet, but as the sky over news events buzzes thicker each day with more news choppers, the chances for such a tragic crash increase. Flying at a safe altitude while relaying signals from the ground provides a margin of safety.

Applied airborne technology

There are a large number of companies offering airborne microwave repeater systems, among them, Microwave Associates, Nurad, Farinon, Tayburn Electronics, RF Technology, and companies like ENG Helicopter Satellite Ltd., which assemble systems from the wide array of radio and antenna gear available in the marketplace. In addition, there are a host of companies that specialize in subsystems, special antennas, radios, camera supports and high-powered optical systems intended for aerial videography.

Basically, an airborne repeater system consists of a microwave receiver and transmitter aboard the helicopter, a power supply, a series of receive and transmit antennas, a camera, videotape equipment, and various air-to-ground communications systems. The location ground equipment usually consist of the camera, audio gear, transmit microwave system, and power supply. A small, relatively low-power microwave transmitter and lightweight antenna are the usual combination selected for the ground-based transmission system. A handy-talkie is also generally available for air-to-ground coordination.

Alex Carey, president of ENG Helicopter Satellite Ltd., points out that space is always at a premium in helicopters. Helicopters, said Carey, "are designed for a pilot and four passengers with very little luggage." The equipment required for a full ENG package generally equals in weight and mass one passenger. So the normal crew complement is one pilot, a camera operator, a reporter, and sometimes a technician, though Carey would prefer to see stations keep the crew size down to two passengers in addition to the pilot. "One less person," said Carey, "can make a big difference in the operation of the helicopter both in terms of the amount of time the helicopter can stay airborne and its flight performance."

Though some pilots, like KOOL-TV's Jerry Foster, are renowned for their ability to report, photograph, and fly all at the same time, Carey would prefer to see the pilot doing little else but controlling the aircraft. In a relay situation the helicopter either hovers (some helicopters do not do this maneuver very well) or circles. If there is a good directional air current, the helicopter can be headed into the wind at low speed and remain relatively stationary against the air current. The selection of an altitude for relay largely depends on the strength of the ground receiver, the propagation pattern of the ground antenna system, and the relationship of the helicopter to the base station receive antenna.

The key element in the base station receive system is the receive antenna. Though horn antennas are used with some success around the country, the current trend is to maneuverable antennas, which have superior operating



Another approach to getting close-up pictures from helicopter-borne systems is being promoted by Microwave Associates. The IsteC bubble mounted on the helicopter contains a remotely controlled camera with powerful optics. The bubble is stabilized by a tri-axis gyro. FAA STC certification for the unit is pending, but demonstrations have shown pictures taken from an altitude of 1000 feet that appear to have been shot with a normal lens from a vantage point only 50-100 feet away. The Gyro system will sell for about \$90,000 to \$120,000

characteristics for airborne operation. Most of the major antenna manufacturers now offer some form of rotatable dish or rod antenna with good remote control systems or auto-tracking features.

The principal radio systems used aboard helicopters for airborne microwave operations are generally in the 2 GHz band, though as that band becomes more crowded, 7 GHz and 13 GHz radios may begin to appear. Generally, the 2 GHz radios are of the 21 channel, frequency-agile type. Single-channel, non-agile radios are also common but as crowding continues multi-channel, agile types are growing more important. Receivers for airborne use are heavily filtered; the best employ SAW (surface acoustical wave) filtering to help minimize interference from other signals in the same band. Moreover, many of the radio antenna systems generate CP (circularly polarized) signals which not only prove beneficial when "bouncing" a signal and in multipath conditions, but also can be used to help alleviate the problems of crowding in the 2 GHz band. Stations routinely coordinate polarization among themselves when they know crowding exists. For example, to further protect against interference in a three-station market where all stations are assigned channels in the 2 GHz band, the common practice is for each station to seek a channel assignment spaced as far from its neighbor's channel as possible. Then each station attempts to select a left or right-hand CP orientation opposite of that selected by its adjacent neighbor.

While this is an effective tactic for land-based systems since a right-hand oriented receive antenna will tend to reject signals with opposite orientation, it is no sure solution for airborne systems. Because of the motion of airborne systems, the orientation of the signal can change from left to right (or vice versa) as the aircraft banks or exposes another view to the receive site. Though a change in orientation will occur whenever a CP signal is reflected, even with land-based systems, the number of reflections during any transmission is predictable.

The result is that most airborne antenna systems tend to be made up of an array of antennas using both CP and

linear antennas. Moreover, helicopter systems frequently employ directional and omnidirectional antennas. The directional antennas tend to have greater reach, but as the chopper flies closer to the receive site, the narrower beam width of directional antennas may make tracking more difficult. Therefore, the omni antenna is used. The same relationship is true on the relay side of the operation.

Another common problem with airborne microwave systems results from their very nature. Because the copter can extend news gathering range dramatically, a station may find itself over a neighboring market, where its assigned ENG frequency and channel are allocated to a station already in that market. This situation generally calls for some quick horse-trading with local stations as well as good coordination among home stations. This is another area where the microwave relay capacity can help out. With good directional radio gear on the ground, pointed away from any local receive site, the same frequency can be used. The helicopter can take up a relay position that is well away from the area and can direct its signals back to the home base using a path that will not interfere with local transmissions.

Studio-transmitter links (STLs) also present a potential problem. While the current trend is toward STLs in the 7 and 13 GHz bands, many STLs are still in the 2 GHz range. Airborne systems stand a good chance of clobbering such 2 GHz STLs with their signals. While the problem can generally be avoided through sound coordination at the home base, it again becomes more difficult when a station's news gathering region extends beyond its own marketplace.

Equipment trend response

As mentioned earlier, the current trend in airborne microwave radio systems is to the 2 GHz, 21-channel frequency-agile types. While frequency agility is not as important in smaller markets where there is less crowding in the band, it is of growing importance in larger markets.

Two other important trends are toward smaller, lighter radio gear and lower power consumption. Microwave Associates at the RTNDA Conference in Hollywood, Fla., this past December introduced a new frequency-agile, 21-channel transmitter that weighs in at about three pounds. As configured, this transmitter can be integrated



Tayburn Electronics' latest mini-transmitter is a 2 GHz, 12 W unit that is attached to the antenna. The unit can be manually retracted, or an automatic retracting device may be used

with the antenna for a one-piece operation that takes up virtually no room inside the chopper. Tayburn Electronics takes a similar approach using a very small, lightweight transmitter, though theirs is available as a one or two-channel unit. A 7 GHz model is also available.

The latest Farinon radios, while generally larger than the two recent introductions by M/A and Tayburn, are frequency-agile. Nurad-supplied airborne systems generally incorporate Farinon radios, while airborne packages from ENG Helicopter Satellite, Ltd., are frequently equipped with either Farinon or Microwave Associates radios. RF Technology utilizes its own radio equipment, which also tends to be downsized and frequency-agile.

Nurad has shown at recent industry gatherings two new airborne systems that it should begin delivering this month. Known as the Copter Pod[™] and Mini Pod[™], these are fully integrated airborne microwave systems packaged in aerodynamically designed housings somewhat reminiscent of aircraft fuel pods in appearance. The Copter Pod contains both a transmitter and receiver, while the Mini Pod provides the antenna array for use with on-board radio gear already in the station's possession. The radios for the Copter Pod will be supplied by either Farinon or RF Technology. The pods attach to the outboard cargo rack of most standard helicopters.

On-board antennas tend to consist of an array offering both CP and linear polarizations. Generally, an omni antenna is selected for close-in transmissions and as the receive antenna for relay operations. In certain circumstances a single antenna can be diplexed for both receive and transmit operations. Two innovations in this area include the use of Clavin cavity antennas in the Nurad pods and the announced intention of RF Technology to develop automatic antenna switching. RF Technology, which manufactures the QA6 antenna for use with wireless cameras (see *BM/E*, October, 1980), believes that a similar automatic switching system can be developed for airborne antenna arrays.

As mentioned earlier, tracking receive antennas are now offered by the three major suppliers, Microwave Associates, Nurad, and Tayburn. The degree of automatic tracking varies from manual meter-assisted tracking to fully automatic tracking. Here there are serious differences in philosophy. Automatic tracking is an expensive function and some believe the degree of accuracy required for an airborne system cannot be achieved without a serious price distortion. The subject of tracking antennas will be taken up in a later issue.

While in the near term broadcasters will continue to rely on the repeater capacity somewhat infrequently, it is an essential function not to be overlooked. As more and more stations adopt airborne ENG, this capacity becomes increasingly important both from a safety and operational standpoint.

BM/E

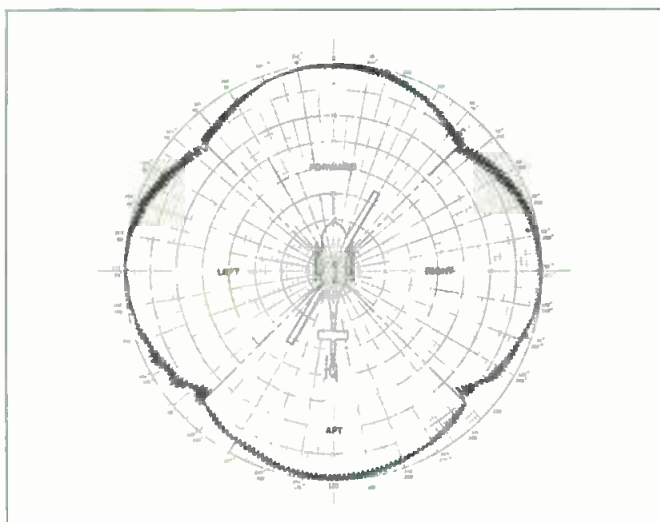

Nurad's new Copter Pod and Mini Pod systems feature five Clavin cavity antennas for higher gain (8 dB) and better multi-path protection

USE THE WEATHER RIGHT, HOLD YOUR LISTENERS

Radio managements can get weather data today in great plenty from a large variety of sources. Radio also has wide scope in tailoring weather data to the needs of listeners. This article describes the main sources of weather data, and shows how weather broadcasts are shaped for maximum usefulness and attractiveness.

MARK TWAIN'S old wheeze still holds: "Everybody talks about the weather, but nobody does anything about it." We can, however, update Mark by noting that a great many people today are engaged in charting the course of the weather, reporting its state, predicting what it will do in the next hour, day, or week, and disseminating that information to millions of people.

For radio broadcasters, the size and complexity of the weather "industry" means that there are a multiplicity of methods for getting weather information and many styles in which it can be received. Furthermore, however broadcasters get weather information, they are free to impose their own styles on the way they deliver it to their audi-

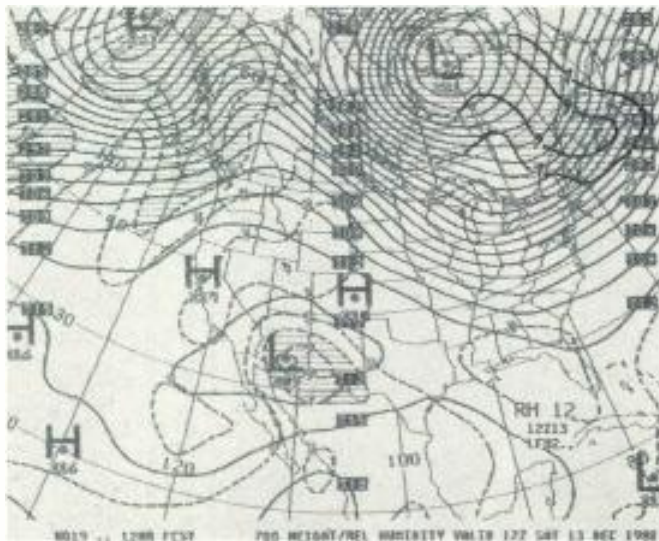

Map sent by NOAA facsimile service shows 12 hour forecast of humidity at various levels. The service is distributed by telephone lines, receivable on facsimile units for NAFAX, made by various manufacturers

ences. Weather information is basic programming; it plays a definite part in a station's impact on listeners. Community leadership in some situations means special handling of weather information, as some of the station stories that follow will demonstrate.

The basic sources

The Federal Government's National Oceanic and Atmospheric Administration (NOAA) is the main source of basic weather information, but it is not by any means the only one. NOAA reaches the broadcaster directly in a number of ways, as detailed in a moment. In addition, there is a large array of private enterprises that take information from NOAA and from other sources and interpret it, analyze it, and put it into special forms for more interesting and informative presentation. Many broadcasters find one or more of these services worthwhile, although they naturally cost a lot more than the information direct from NOAA (which is very inexpensive).

A few broadcasters with special interest in weather get at least some of their information themselves with their own weather instruments, usually to supplement the national sources. A trend of the moment is the development of sophisticated weather instruments at prices that seem reasonable to radio broadcasters. Thus it seems likely that more broadcasters are going to "roll their own," at least for highly localized information that they can't get from other sources.

In this article *BM/E* will first outline the use of basic weather sources and of the various "service" operations that are flourishing at the present time. Then we will describe a number of actual broadcast operations that demonstrate various ways of using weather on the air. A companion article in this issue covers similar ground for television broadcasters, whose needs for special presentation of the weather are much more extensive than those of radio operators.

Interfacing NOAA

As a tax-supported operation, NOAA has developed a number of ways of getting its weather information cheaply to users, especially to the media. NOAA, of course, collects a vast amount of weather information from a variety of scientifically advanced observation posts all over the country. This information is routinely sorted and assembled into reports and predictions that are localized to a certain extent (though not closely enough for some users: see below). NOAA also puts out bulletins and

Look into a JVC 3/4" TapeHandler. Now.

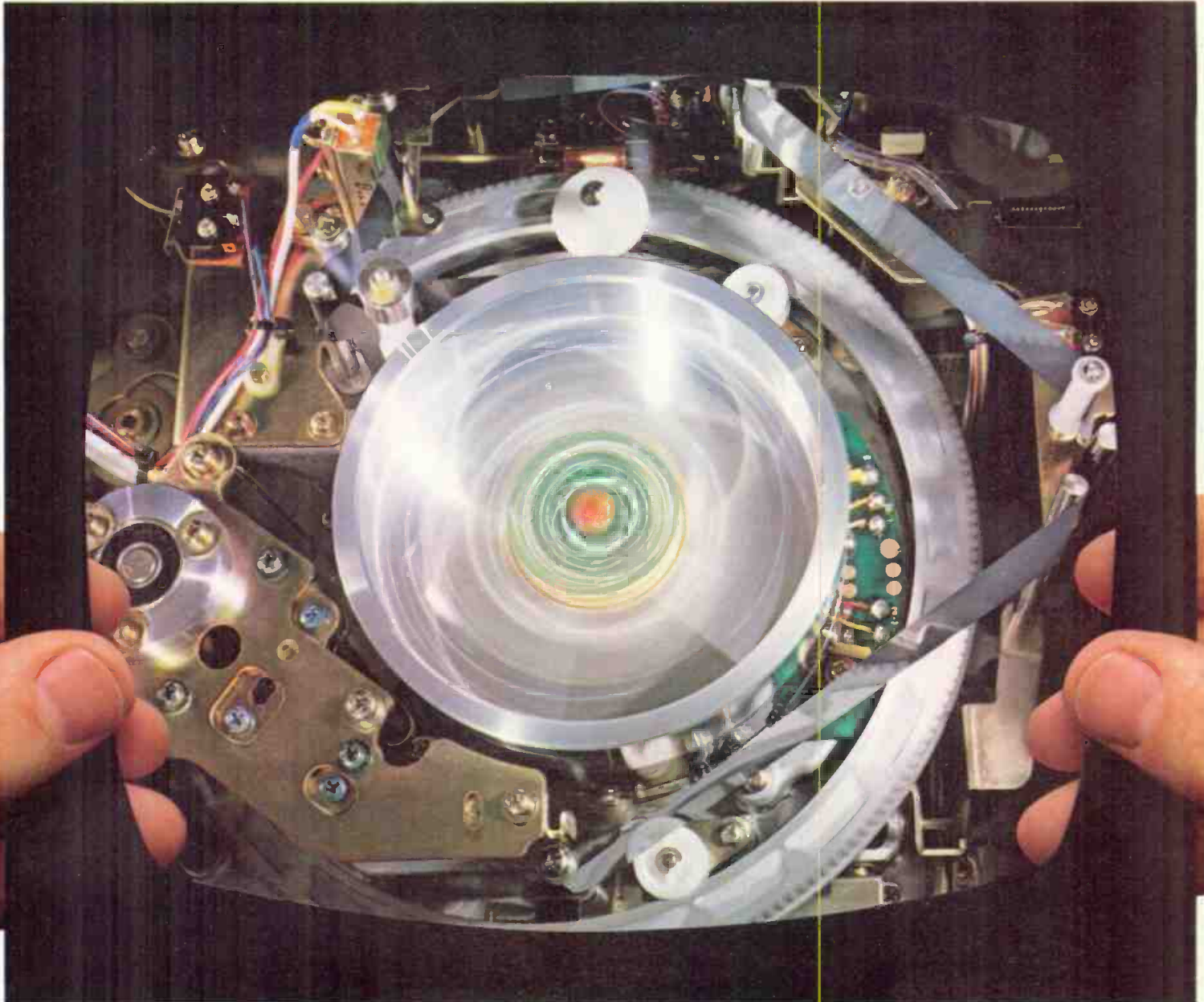

JVC has taken a close look at 3/4" Video Cassette Recording with an eye for what you've been looking for. Stability. Reliability. Gentle tape handling. Economy. The result is a full line of recorder/editors, full-function recorders, cost-efficient players, and microprocessor-based remote control units with utmost versatility, broad interfacing capability.

Take a look inside one of JVC's Tape-Handlers...the CR-8200U Recorder/Editor, the CR-6600U full-function Recorder with assemble-editing capability, or the CP-5500U Player with on-air quality...and you'll be amazed at what you don't see.

No pulleys. No belts. No idlers.

Instead, a 7-motor direct drive system that keeps tape tension constant for smooth and reliable tape transport, reliable tape shuttling. A simplified tape threading mechanism for gentle tape handling. Brushless DC motors that directly drive the capstan, head drum, and reels to give stability and reliability.

To go with them, there's a choice of compact control units: the easy-to-operate RM-88U Editing Controller for precise timing of machine functions, the low-cost RM-82U Editing Controller, and the RM-70U

US JVC Corp. Dept. BM/E 1/81
 41 Slater Drive, Elmwood Park, NJ 07407

Please have a representative call.
 I don't want to talk yet. Just send literature.

Name _____
 Title _____
 Company _____
 City _____
 State _____ Zip _____
 Phone _____



full remote control unit with shuttle search function.

Get all the details. Send in the coupon, phone toll-free 800-821-7300, Ext. 7005 (In Missouri: 800-892-7655, Ext. 7005).

**Your choice.
 Now. JVC®**
 US JVC CORP.

Circle 143 on Reader Service Card

© 1980 US JVC Corp.

Use The Weather Right

warnings covering weather emergencies of every kind.

There are two very inexpensive ways to get NOAA's regular weather reports and emergency bulletins into the station, all day every day. One is the NOAA teletype service, which comes in by dedicated telephone line. In most areas, NOAA will pay the cost of the telephone line from the NOAA station to the local exchange in the broadcaster's city. The broadcaster pays for the local line into the studio and must rent or buy a standard teletype machine. The regular reports come in 24 hours a day, repeated several times an hour and updated at least every hour. Special bulletins come whenever needed.

Broadcasters have a lot of flexibility in the way they put the NOAA information on the air. This ranges from having a DJ read the latest report at certain intervals all the way to having a weather "showman" who gives the information the flavor and personality the management is trying to project and interprets it for the station's particular audience.

The second easy way to get regular NOAA information is through FM broadcasts on the 160 MHz band, delivered by an array of more than 300 NOAA transmitters set up in every part of the country specifically to disseminate local and national weather information rapidly and widely. The broadcaster needs a receiver designed for this service. The nearest NOAA transmitter is likely to be within 40 miles of the station, although there are a few areas where the distances are much greater.

A large number of firms make the receivers, at prices ranging from \$50 or less to a few hundred dollars. The more sophisticated receivers include automatic relay systems that respond to alerting tones sent out by the NOAA transmitter. A tone at 1650 Hz goes out when there is a routine updating of the weather report. The receiver responds to this tone by starting a recording system to get the report.

A 1050 Hz tone is for special bulletins and warnings. On the "automatic" receivers this tone not only starts a recorder, but also demutes the receiver so the warning can be heard, and closes a relay that can be used for any kind of alert signal. A receiver of this kind used by many broadcasters is Gorman-Redlich's Model CRW; it has pushbutton tuning for the three frequencies used in the band. At least 35 other firms make receivers for the service, some single-channel crystal sets that can be carried by hikers or motorists, and others of the more elaborate kind just described. Makers include Lafayette, Radio Shack, Heath, General Electric, Zenith, RCA, and many others.

The NOAA radio reports can be put on the air directly;

One of the first weather radars installed by a radio broadcaster, a Sperry Marine at KWOA in Worthington, Minn., has provided excellent coverage of tornadoes and other local storms. Right, antenna on station roof; far right, screen in control room



FCC has issued standing authorization for this. They also can be put on the air from recordings, but this must be done within an hour of the receipt of each report.

Facsimile from NOAA

Another delivery channel set up by NOAA to get weather information to the media is a facsimile service that delivers a variety of graphics over telephone lines. Included are radar plots, charts and graphs, and tables of various kinds that show weather conditions and predictions in considerable detail. The system also sends out selected charts showing the information collected through the satellite observation system, which photographs the United States from a geostationary orbit at regular intervals (the Geostationary Observational Environmental Satellite, or GOES).

To get this graphic information, the broadcaster needs a special facsimile receiver and chart recorder, which takes the signals off a telephone line and turns them into hard-copy visual material. A number of firms build the receivers. One is Alden Electronic of Westborough, Mass., selling receivers for two classes of facsimile service: one is NAFAX, NOAA's National Facsimile service, and the other is DIFAX, a similar service using digital transmission for higher resolution and requiring special conditioning of the telco line.

Radar remotes by phone

Also used by some radio stations, but mostly by television broadcasters (see TV story in this issue), are several services which, in effect, carry to the station a "remote" readout of the actual radar plot at the NOAA observation post. NOAA operates weather radars in most localities around the country. Some private firms have worked out an agreement with NOAA to install a pickup of some kind at the NOAA plant to get the radar information in transmissible form. The information goes by slow-scan television over telephone lines to the broadcaster, who has a readout system, also supplied by the private firm, that reproduces the radar plot in the studio.

The system can use simply a TV camera in front of the NOAA radar screen, feeding slow-scan signals onto the telco line. Higher resolution naturally results from feeding the NOAA signals in electrical form into the slow-scan transmitter.

This service can become very elaborate, as the TV story shows, with color added for various degrees of precipitation, automatic overlays, and graphics on screen to put the message into words. The objective here is to get something that will be attractive and impressive when the TV broadcaster puts it on the air. The radio broadcaster, of course, doesn't need this and can sensibly avoid the very high cost of these systems.

when it comes to weather, Arvin has the receivers to tweak your station's

VIDEO EXCITEMENT

through automatic colorizing direct display products like...

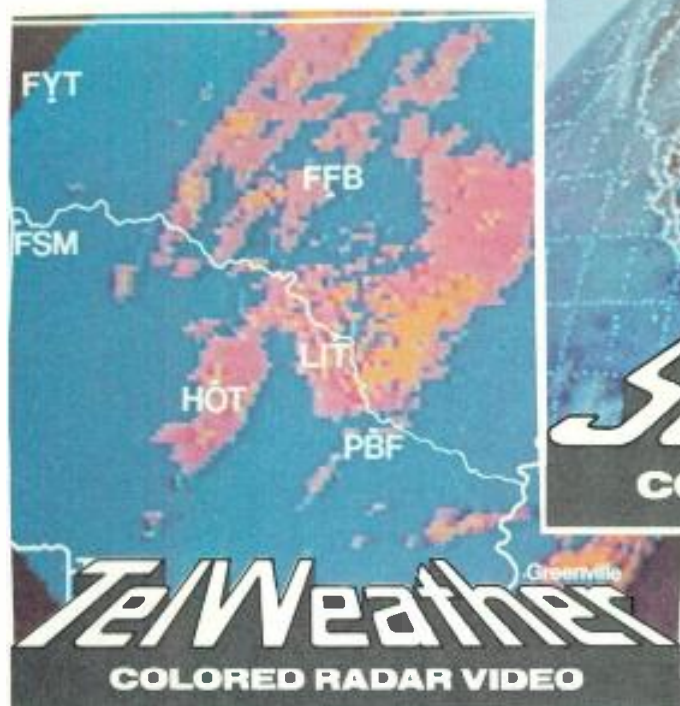

Let Arvin color your world while cutting your costs! Tel-Weather radar receivers and Sat-Weather satellite receivers produce vivid color video signals automatically from the NWS data to show precipitation intensities and storm systems (respectively).

Write or phone Dick Richards or John Saurenman, 614 - 756-9211 for price and delivery information.

ARVIN

4490 OLD COLUMBUS ROAD, NW, CARROLL, OHIO 43112 TEL. (614) 756-9211

Circle 144 on Reader Service Card

Use The Weather Right

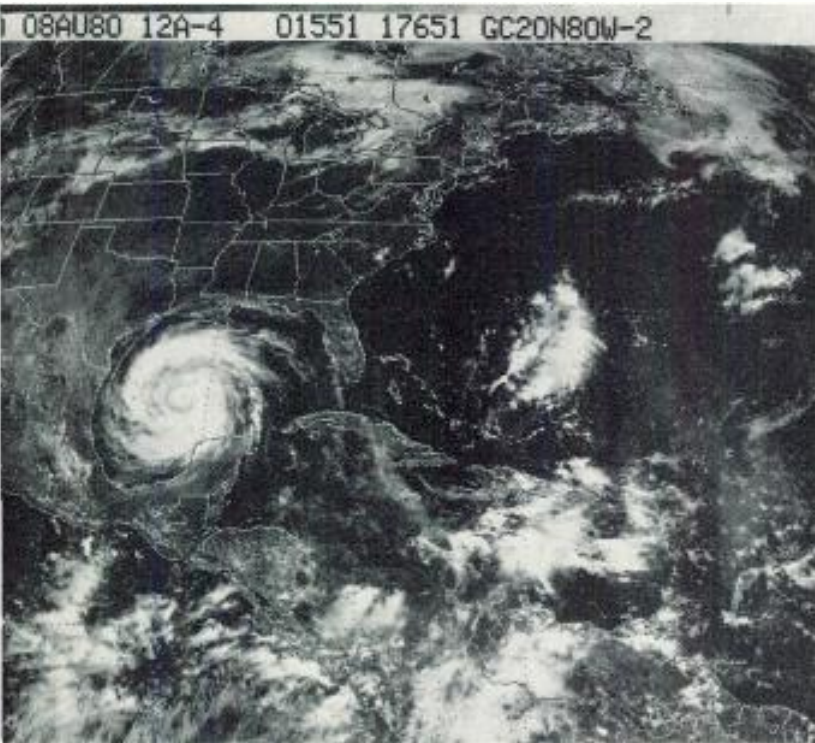

Satellite photo from the Geostationary Environmental Satellite (GOES) shows Hurricane Allen in the Gulf of Mexico on August 8, 1980. The GOES photos can be received from NOAA via digital facsimile with a DIFAX receiver

NOAA consultation

A way of getting detailed information from NOAA that broadcasters can easily overlook is simply going into the nearest NOAA office to ask for help. A spokesman for that organization pointed out to *BM/E* that there is always a vast quantity of graphic and other information that extends and enlarges the advisories sent out. There are usually staff persons available for consultation, too, although the degree of availability will vary from one station to another. This is not useful for hard-breaking weather news, but could easily be helpful to broadcasters looking for expert, long-range advice. It seems a good idea, too, for broadcaster personnel to make themselves known to NOAA personnel who can help by telephone when quick advice is needed.

Private forecasters: humming business

Weather prediction has been big business for a long time outside the broadcast industry. There are scores of firms that tell their clients what the weather will be and get paid well for doing it.

In the last five years or so radio broadcasters have signed up private forecasters in increasing numbers. Two important things a private forecaster can give a radio station are *localization* of predictions to the specific areas occupied by the station's audience and *on-air delivery* of the weather news with a combination of professional authority and style. This appeals to a station whose staff does not include anyone with the background to give the weather the desired flavor.

Private forecasters usually give radio managements the choice of getting material in script form or in voice form; the latter is for recording or airing directly. The meteorologist can usually be introduced on the air just as though he or she were on the station staff.

The staff meteorologist

A sizeable number of radio stations have one or more weather professionals actually on the staff, part-time or full-time. This becomes attractive when the station's audience includes a lot of people for whom accurate, detailed weather prediction is important, as it is in farm areas, for example, or in tornado areas (see below). The staff meteorologist works with NOAA data and information from other sources, fashioning it into broadcasts that serve the station's audience most effectively.

Equipment for reading the weather

Aside from the units needed for the special services already described, the radio broadcaster can get a variety of equipment to help read the weather. Perhaps the simplest of high value is the "weather computer," essentially a readout device for sensors on the roof of the studio. Typical is the Heath ID-4001 (somewhat similar units come from a half-dozen other firms). This includes a computer that turns the output of the rooftop sensors into digital readout information, which can be brought right next to the operator in the control room. Variables covered usually include temperature, humidity, wind direction, and wind velocity. The computer also includes enough memory to show maximums and minimums over any reasonable period, as selected by the operator.

Radar: ultimate warning tool

A lot of the services already described, including a large part of NOAA's reports and warnings, are of course based on radar studies of the atmosphere, which have been refined in recent years to show great detail — good estimates can be made of precipitation strength, storm movement, etc. Just beginning to get into use by radio stations is the private radar system, owned and operated by the station management itself. Systems are now coming onto the market at prices radio managements can contemplate.

With radar of its own, a station management is in position to serve a community extremely well on the weather front. (See story below on KWOA). Some of the first radars being marketed to broadcasters are from Sperry Marine, very long established in radar production. Prices are in the neighborhood of \$10,000 for a complete system: transmitter, antenna, receiver, readout. Broadcast Consultants, of Leesburg, Va., has been a principal marketer.

The radar screen will show, and plot the course of, every storm in the area covered, normally up to 60 miles or more in radius. This is especially effective in watching the progress of tornadoes.

The helicopter for eyeball reports

A piece of equipment that can double as a weather instrument is the station helicopter. With a two-way radio on board, the helicopter pilot can tell the studio not only about riots, traffic jams, etc., but also about any local storms. The pilot may be closer to the object than any other "sensor" in use for weather reports. Some stations have found this an excellent supplement to their regular weather report channels.

WXRT, "straight" on weather

WXRT-FM has successfully fought the Chicago radio horde with progressive adult music and a super-clean signal (see Best Station story in *BM/E*, December, 1979).

ARVIN/ECHO: Innovation in Intelligent Video Production Equipment.

Arvin/Echo is a division of the Arvin Applied Technology Group, one of the most comprehensive and prestigious private research and development companies in the world. As a technological leader, Arvin/Echo has built its reputation on producing rugged, reliable broadcast production equipment.

EFS-1A: The EFS-1A offers the industry an extraordinary Frame-Stor™ Recorder in a small package (38 pounds). It is also available in PAL/SECAM. The relative low cost of the EFS-1A enables broadcasters to install a system in news, production or wherever the capability is required. The unit uses Arvin's unique, flexible Discas-
sette® which electronically stores 400 slides (200 per side), is virtually indestructible, and is interchangeable with any EFS-1A System in the world. Remote random access to the EFS-1A System is also available with an optional interface to character generators.



SLO/MO™-1: Another use for the Arvin/Echo Discas-
sette principle is the capability to provide the instant replays which are expected by sports fans. The SLO/MO-1 is a versatile production tool which is light weight, rugged, transportable and sells for a reasonable price. The system gives broadcasters capabilities such as slow motion, freeze/frame select and time saving editing. SLO/MO's usefulness in sports, news and commercials is enhanced by its High Band Color, Digital Comb Filter, Digital Time Base Correction and Digital Field Storage.



And now . . . The IMAGE MAKER®

Imagine, an incredibly versatile disc recorder which can animate, store stills, and record and playback in real time (30 frames per second) to single frame. Or, at the touch of a button, 24 frames per second for film transfer. Add to this full random access, with preview, of up to 500 images on line and the ability to pre-set 64 locations, standard serial digital interface, and a built-in frame by frame editing/animation previewer.

That's Arvin/Echo's total production tool: The Image Maker. Whether your requirement is to store still frames, produce exciting animation

sequences or preprogrammed motion loops from 16 frames (or less) to 500 frames, this high band color recorder is capable of delivering direct or processed video. Rugged, reliable, and portable, The Image Maker is the only real time random access recorder featuring interchangeable Discassettes® which doesn't break the bank.

Remember, Arvin/Echo has more video disc recorders operating in the broadcast field than any other manufacturer. Based on this unique experience, we have built The Image Maker to meet the rapidly changing challenges of the professional television industry. It's potential is limited only by your imagination.

ARVIN/ECHO™

485 E. Middlefield Road, Mountain View, California, 94043
Telephone: (415) 961-7145, TWX: (910) 379-6499

APPLIED
TECHNOLOGY
GROUP **ATG**
ARVIN

Circle 146 on Reader Service Card

Use The Weather Right

The station runs on its carefully built reputation for doing music extremely well. For weather, the management wants to be completely up-to-the-minute and authoritative, but not comprehensive. WXRT believes the station's listeners want the news, including the weather, quickly and cleanly on the hour. Chicago has several "talk" stations; WXRT does not want to compete with them, having proved the wisdom of building well for one kind of listener in a very big city.

For this approach to weather the NOAA radio system is ideal. The reports are right on the minute, and they can be shortened or put on the air as they come. They are always on tap for airing when the radio operator is ready. They give a station that is not heavily into news an authenticity in its weather reports. WXRT feeds the NOAA signals right to the operator's position.

KWK, three miles from NOAA

Another station finding the right character in the NOAA radio reports is KWK in St. Louis, Mo. This Top-40 station, recently rebuilt by a new owner, Doubleday, has to be on top of tornadoes in the area for very fast warnings to listeners. Luckily for KWK, the local NOAA radar is only three miles from the studios, and covers the city area almost exactly. NOAA's tornado advisories, which can be updated every few minutes if necessary, are received on one of the 160 MHz sets and brought right into the main console, with a punch-up to the monitor speaker.

There is a regular break on the hour, ordinarily with 10 seconds of weather. The operator can air part of the NOAA broadcast or summarize one he or she listened to just before. If there is a real emergency, the DJs incorporate it into their patter and update the information as seems



NOAA facsimile map covers the United States with equal-pressure lines to show areas of high and low pressure across the country

necessary. KWK's audience is never left with the feeling of being out of touch.

Two meteorologists, five stations

In Worcester, Mass., at WSRS, flagship of the Knight group of five stations, all in smaller New England cities, the NOAA facsimile service brings in a constant stream of graphics with detailed weather information. Two staff meteorologists study the data and prepare broadcasts for the top of the hour throughout the day. This is ordinarily 90 seconds, but if the information warrants it a continuation of the weather report goes on after an interruption for other material. The management believes that listeners like this change of topic.

The weather reports go by telephone, or by subcarrier on the WSRS carrier, to the other stations in the group, which are in Fall River and Fitchburg, Mass. and in Manchester and Portsmouth, N.H. The meteorologists tailor their reports for each locality. The programming of the stations is basically MOR, but the management believes that authoritative, timely, and well localized weather is an essential part of the stations' hold on listeners. The system they have worked out to get that kind of weather reporting seems solid in value and comparatively low in cost for a five-station operation.

WBEN, essential storm warnings

In Buffalo, N.Y., WBEN-AM and FM have a special responsibility as big-city stations in a weather-plagued area. Buffalo, of course, gets snowstorms of the most virulent kind through long winters.

WBEN is also the EBS control station for its area, charged with alerting the other stations in the local EBS net when an emergency message is due and with originating the message. For all these reasons, the management has put together a comprehensive operation for getting weather news in quickly. The station has the NOAA teletype service for basic weather advisories. There is also an arrangement with the local NOAA station to call WBEN by phone if any weather emergency seems to require EBS action.

In addition, WBEN has hired the services of a private forecaster, Weatherfax of Dayton, Ohio, to which the NOAA facsimile line as well as the radio reports go regularly. Weatherfax thus keeps in constant touch with the Buffalo radar station of NOAA and can call WBEN instantly if the weather news warrants it; this is in addition to preparing regular newscasts from the mass of data received.

David May, chief engineer, pointed out to *BM/E* that snow predictions are "hot" news in the area, not just

KWOA - KWOA FM STEREO WORTHINGTON, MINN.
730 AM 95 FM

SKYWATCH STORM MAP

RADAR STORM MAP INSTRUCTIONS

Listen to KWOA (Radio 730 or KWOA FM STEREO RADIO 95, and when severe weather occurs or threatens, our Radar Weather reports will give exact locations of all storm cells as you can plot their location and movement with the map grid coordinates. Grid lines are approximately 10 miles apart. 1 inch = 30 miles.

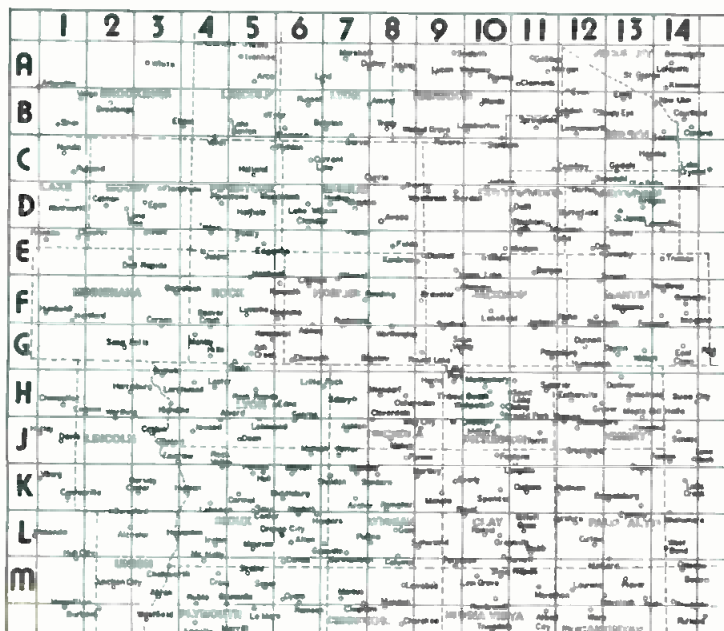

Storm map supplied to listeners by KWOA shows surrounding area with grid for precise location of storms. Coordinates are broadcast in weather reports so listeners can place storms exactly

Now... Continuous GOES picture printout

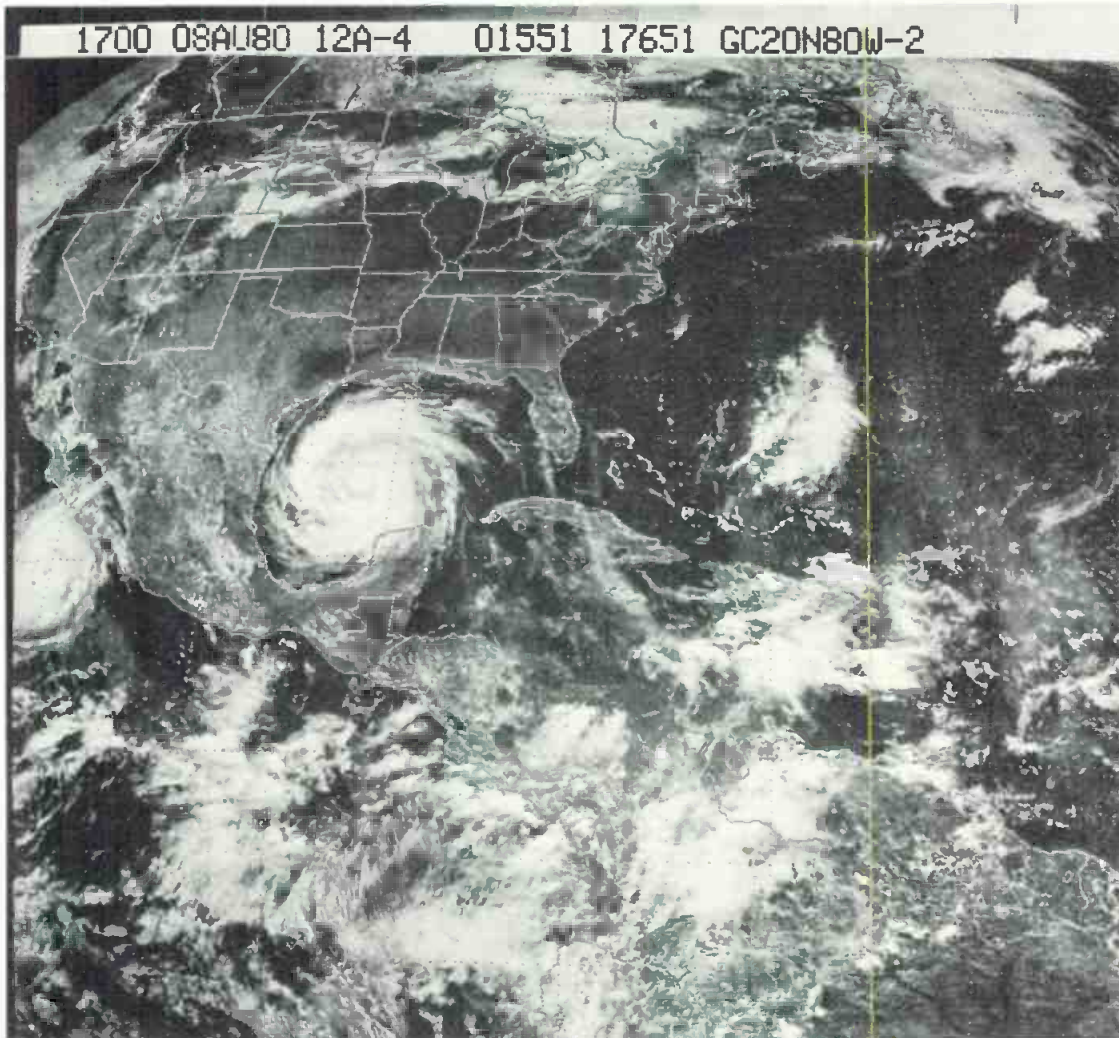

...for the cost of a private phone line

You can now receive dramatic GOES (Geostationary Environmental Satellite) sectors generated from the full earth disc through a service provided to your local Weather Service Forecast Office.

Infrared and visible GOES pictures, covering major portions of the United States, are transmitted at intervals throughout the day and can be received on ALDEN 1800 and ALDEN 1100 Facsimile Recorders.

Phone companies at the various Weather Service Forecast Office locations will furnish the GOES signal to all external users who apply to the National Weather Service Headquarters for an agreement. This provides a valuable service at a considerably lower cost than was previously available.

Pictures received on the ALDEN 1800 are large...18 inches wide by any transmitted length and contain up to 16 tone shades of useful discernible information. Pictures are seen as they are printed...no waiting for complete picture and post picture processing.

The ALDEN Facsimile Recorders provide unequaled reliability and unattended operation and are backed by the ALDEN name and a nationwide service organization.

To learn more, fill out the coupon or call the ALDEN Sales Department at 617/366-8851.

36B



ALDEN
ELECTRONIC & IMPULSE RECORDING EQUIPMENT CO., INC.
WASHINGTON ST., WESTBORO, MASS. 01581
TELEPHONE: (617) 366-8851 TELEX: 94-8404

Please send complete data on the ALDEN 1800 and ALDEN 1100 Facsimile Recorders for receiving SMS pictures on GOES circuits.

Please send complete data on other ALDEN weather map recording systems:

ALDEN 600 and 1100 Weather Radar Recorders.

ALDEN 1100 and 1800 Facsimile Recorders for the NAFAX Circuit.

ALDEN 1100 and 1800 auto select Facsimile Recorders for NAFAX Circuit.

Call me at _____

Name _____

Address _____

City _____ State _____ Zip _____

ALDEN...THE FIRST NAME IN WEATHER CHART/PICTURE RECORDERS.

Circle 145 on Reader Service Card

NEWSPORT 300



Improve your field communications with a Newsport 300.

The Newsport 300 makes everyone happy – the field reporter, the sports caster, and you.

The Newsport 300 is a compact, versatile, high performance field production mixer. This 3 channel mixer handles 3 microphones and 2 headphones. And with switch selectable outputs and a built-in cassette recorder, the Newsport 300 connects to any telephone or 2-way radio to feed high level studio equipment, air live coverage, or record interviews for later broadcast

And all in one very portable package. The complete console, tape recorder, headset, microphone, news copy stand, writing desk, and all cables, fit into a single carrying case. The Newsport 300 runs on AC, DC or internal power, so the story is never out of reach.

Find out just how affordable an investment in one or more Newsport 300's can be. Call us at 408/926-3588 and let us show you how, no matter where you go in the field or on the field, the Newsport 300 goes with you.

SALES AND SERVICE Sound Dynamics Inc.
P.O. Box 32055
San Jose, CA. 95152
408/926-3588

Sound Dynamics Inc.

From Sound Dynamics –
Bringing quality technology to the audio world.
Circle 147 on Reader Service Card

Use The Weather Right

because of the potential for disruption, but also, in a positive sense, because a very large sports industry depends on winter snow. WBEN's authoritative weather reports are very high with listeners in the city and its surroundings.

KWOA, a radar just for the town

In Worthington, Minn., KWOA-AM and FM have been strong elements of the community for many years and highly successful as radio businesses. As James Wychor, vice president, explained to *BM/E*, the town is in the southwest corner of the state, right in a "tornado alley." The closest NOAA weather radar is 180 miles away; another is 180 miles, the third closest is 300 miles (Des Moines, Iowa). Because of the curvature of the earth, radars at that distance can pick up only disturbances that are high in the air, 40,000 feet or more. Tornadoes are lower; they tend to sweep through the area over and over, ahead of warnings. The management of KWOA about 15 years ago adapted an ex-Navy radar for local weather scanning, and was able to improve local weather warning service considerably. However, the real "fix" for residents of the town and the surrounding area came about a year ago when KWOA put in the first of the Sperry Marine radars to reach a radio station. The Model MK-104 has performed admirably, according to Wychor, and KWOA has consolidated its position as the community's source of vital weather information.

The antenna for the radar system is on the station's main building, and the screen is right in the control room. KWOA is also the EBS control station for the area and, like WBEN in Buffalo, has the special responsibility of alerting other stations in the local net to emergencies, including weather emergencies. Wychor says the management takes this responsibility seriously; the weather radar is a vital asset in this connection too.

The station's weather reporting has become so outstanding that the State Highway Department has instituted a plan under which the station gives road and weather information every 20 minutes when conditions are poor. The state has put up signs along all main roads telling motorists to tune to the station for this information. This solid position in weather news is on top of the two stations' regular programming, which is country music and lots of farm information on the daytime AM, Adult Contemporary music on the 24-hour FM.

At the time of the *BM/E* interview Wychor reported a blizzard in progress, with snow cutting visibility to less than 200 feet. KWOA, of course, had told listeners in timely fashion that a heavy snowstorm was on the way, and galoshes no doubt came out of closets wherever they were needed.

To help develop the skill needed for interpreting the radar plots, KWOA personnel have spent considerable time with experts at the nearest NOAA station. Wychor reports that the weather staff there has been helpful to a high degree. Two engineers on the station staff are competent in radar operation. With this combination of skills and instruction, the KWOA staff has been able to use the radar information effectively.

KWOA's management has the satisfaction of outstanding community service. The high success of the business is, no doubt, in part a result of the leading position on weather the station has built. **BM/E**



FAST, EFFICIENT KEYPAD OPERATION



LOGICAL MULTI-LEVEL CONTROL DUAL BUS KEYS

The 4000 Series. Creative Results Made Simple.

We call it human engineering. You'll call it terrific. The 4000 Series Switcher from Ampex is powerful enough to get almost any effect, yet so simple to use that your production is right the first time everytime.

We Started Logically.

Most good ideas are basically simple. In essence that was our approach to the design of the 4000 Series Switcher.

For instance, take upstream keying and multi-level video processing. Signal flow is both obvious and logical for the operator. Processing takes place left to right and top to bottom.

And with one M/E and the 4000's dual bus keyer, you control five levels of video. This means tremendous power when you need it. One 4000 Series M/E is the equivalent of a conventional switcher's two or three M/Es.

This logical technology will not only give you unlimited creative freedom, but also this simple assurance: the 4000 Series Switcher will never be the weak link in your production chain.

Simplicity Is as Close as Your Fingertips.

What could be more logical than to control all vital functions from one, easy to use keypad. Nothing, of course, unless climbing all over a switcher is simplicity.

The 4000 Series keypad control is both logical and extremely fast! Setting-up or changing set-ups can be done quickly and with confidence. You'll have fingertip control of 100 different patterns, 99 transition rates, and ten key sources.

The 4000 Series Switcher. It's From Ampex!

That means Ampex stands behind it. We

built the 4000 to be rugged. And because it's built by Ampex, you can count on service when you need it.

The 4000 Series from Ampex. Its creative results and simple operation make it the logical choice for all productions.

Get the 4000 Series edge. Call your Ampex representative today!

Get The Ampex Edge.



Ampex Corporation
Audio-Video Systems Division
401 Broadway
Redwood City, CA 94063
415/367-2011

Circle 148 on Reader Service Card

DC control and the



Introduced by Ramko in early 1975, DC control of all audio attenuation and switching has since proven itself so superior to conventional methods of audio control that most manufacturers of consoles are still trying to catch up.

The three major advantages are:

1. The DC controlled console exhibits far less susceptibility to RF pickup and external interference than conventional consoles that control audio directly. The conventional console must route all of its audio from the inputs to the various controlling elements (mixers, switches, etc.) and then finally to the console output. The DC controlled console, on the other hand, eliminates all of this audio wiring and thus reduces the pickup of outside interference.
2. It is also less prone to be affected by mechanical malfunctions or problems such as those from scratchy pots or noisy switches.
3. Since all audio switching is done through DC control (+6V or -6V), all internal and external functions (mute, on air lights, remote equip. start/stop) are programmed by simply setting internally located switches. Only one pot is needed to control both left & right channel audio simultaneously (stereo); thus the tracking error normally associated with dual ganged pots is eliminated.

No soldering or internal wiring is necessary to set up or change the "ON AIR" light relay, muting, or AUX MUTE relay. All of these functions are programmed through internally located switches, which can be changed at any time.



What's happening. At a glance.

The labeled, computer-type, push-buttons and corresponding back-lighted displays afford the operator instant recognition of the next happening, which one to push, and what is happening now or what has already occurred. Although we automatically send you a form (at time of ordering) that enables you to tell us how you would like your console labeled, your unit comes with a full set of additional labeling so that you may easily change at any time desired.

The large LED output mode display has two separate functions. The lighted

decimal point, which lights whenever that mixer is potted down into CUE, also a blinking warning light whenever this channel has a live microphone activated. The second function of this display tells the operator whether he is in the Program (P), Audition (A), Cue (C) or Off (blank) mode. It is important to note here that the operator has 2 separate means of initiating the Cue mode. One in the normal fashion of potting down and one via the output mode select switch (C). Thus he may go directly to Cue by pushing (C) without having to change the mixer setting.

The exclusive patch panel for selective input gain offers extraordinary flexibility. At any time, any input can be made to accept anything from a mic level through a line level signal. Not just mic or line level but anywhere in between. Thus on our 10 mixer model you have a minimum of 4,194,304 combinations of mic through line level inputs. And you can accommodate mics and high level inputs or the same mixer simultaneously. You simply plug in the prescribed resistor which are included with your console and that's it.

All the push-buttons on the console are super-quiet. Not the usual loud, clanging, short-lived mechanical switches. The push-buttons switch and route the audio through solid-state logic, error-free, in less than 2 tenths of 1 million of one second. No pops, clicks or mon-

superior console.

Features

- Dual channel
- 5, 8, & 10 mixer versions
- 4 inputs per mixer
- Patch panel gain select inputs
- Back-lit status displays
- Built-in talk back
- Solid state led VU meters
- Mono/phase meter on stereo consoles
- Mono output on stereo consoles
- Custom lettered input push buttons
- Two cue modes (push button and/or pot down)
- Plug in electronics
- Differential balanced inputs and outputs
- DC control—no audio on front panel
- Zero tracking error on stereo consoles
- 3 power supplies w/AC line filtering
- High Z bridging inputs
- Switch selectable cue and mute on all inputs
- Optional digital clock and production timer
- Optional remote equipment start/stop
- 4 year parts and labor warranty
- 2 week trial period

tary feedback with partially actuated switches.



The pure clean difference.

It all comes down to a marked difference in reproduction.

FIRST, all inputs and outputs are solid-state balanced. Unlike transformers they are quite insensitive to impedance mismatches. In fact the mismatches can be millions of times. And can be more than the specified impedance without any noticeable effect on distortion or response. Not so with the average audio transformer as even a couple times mismatch can invalidate the console's performance.

SECOND, our solid-state devices exhibit far less distortion and flatter response than even the finest transformer available today.

THIRD, since the solid-state devices are purely resistive they are much less susceptible to hum, RF and other external interference.

A FOURTH and very large consideration is the LED "VU" meter. This solid-state meter (SSM) has an exceptionally fast response and you can actually see overmodulation peaks. With a mechani-

cal meter you can't. Couple this with the electronic circuit that gives the SSM "VU" ballistics on the decay and you end up with a tighter, cleaner sound than ever before. At the same time, your normal audio power level is still maintained. In addition, the bright red and yellow LED display is legible up to 30 feet away.

Although the mono DC-38's have a meter for each output, we took the stereo versions a step farther. In addition to the left meter and the right meter (switchable, Aud. or Prog.), we included a third to monitor the stereo mix (mono) output.

By throwing a switch located next to it, this meter is converted to a phase check meter and may be used to check the stereo phasing of any and all of the console input sources.



Reliability particulars.

All of the LED's and lamps have a life expectancy of 11 years. The push-button select switches are spec'd by the manufacturer at 20,000,000 operations (1 actuation every 30 seconds, 24 hours a day for over 19 years). The mixer pots are a custom design using glass-hard, conductive plastic. The mechanical construction of these pots is so sturdy

that they tolerate even the heaviest handed operator.

In addition, all of the quad operational amplifiers are burned in for 3 days to insure reliability. Since the power supply is the backbone of your console, you will find not one, but three separate supplies! One for the main audio, one for the monitor amplifiers, and one for the displays. These supplies are fully protected against shorts and over-heating and utilize massive heat sinking rated much higher than necessary.

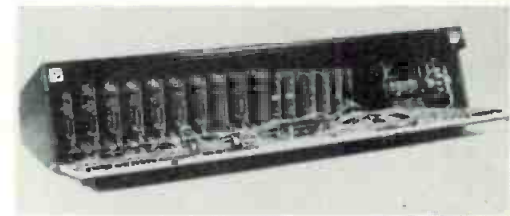

The two week trial.

Put the DC-38 on trial for a full 2 weeks. Put it through a battery of tests or on the air, or both. You'll find that with all that sophistication it's a breeze to use and amazingly rugged.

Write Ramko Research, 11355 Folsom Blvd., Rancho Cordova, CA 95670. Or if you can't wait for the mail, contact your nearest rep or call (916) 635-3600 collect and arrange for a 2 week free trial.

RAMKO

PHILIPS®



World Class TELEVISION

The internationally recognized camera and broadcast equipment technology preferred by broadcasters, production companies and industry around the world:



LDK-14

The years-ahead 2/3-inch field and studio camera family. Now with triax capability.



LDK-5B

Digitally controlled triax version of the LDK-25B for studio and remote location applications.



LDK-25B

Newest version of the World Class, state-of-the-art LDK 25/5/15-camera family. With innovations used by ABC in exciting coverage of the Winter Olympics.

Plus... a wide array of innovative World-Class products like:

Transmitters and Exciters

Fastest growing UHF/VHF transmitter line in North America.

Video Tape Recorders

1" type C, system and stand-alone.

Digital Noise Reducer

Fully automatic.

New, Synch and Timing System

Built around ultra-stable Philips SPG sync generator.

Test and Measuring Equipment

Modulators, demodulators, VITS analyzer & generator, and new waveform monitor and vectorscope.

New, Teletex

Text display system component.

Contact your Philips representative today, or, for more information, write (indicating product interest) to:

PHILIPS BROADCAST EQUIPMENT CORP.
91 McKee Dr., Mahwah, N.J. 07430
(201) 529-3800

PHILIPS®

ELECTRONIC WEATHER GATHERING



With modern weather forecasting systems and some sophisticated weather services, television stations are offering their audiences more accurate information than ever before. Weather is now important news as stations discover how much this information is relied upon.

A TV WEATHERCASTER waving a grease pencil over a regional map was once a common sight. Like the horse and buggy, grease pencil forecasting is rapidly being sacrificed to high technology. TV stations are buying dialup and computerized weather systems, receiving satellite weather pictures, and even buying their own radar.

Long-term increases in equatorial-to-polar temperatures and ground-to-atmospheric pressures have made freak weather conditions the rule rather than the exception. Sudden precipitation, ice, wind, and snowstorms demand that TV stations offer real-time weather reporting. Urban localities are plagued by flooding when sewerage systems cannot drain off torrential downpours. In the Midwest, farmers are unable to spray pesticides without assurances about impending precipitation that could render their spray useless.

In Minneapolis, KSTP, the Hubbard Broadcasting flagship, uses a complete array of weather services. Gene Rubin, weather service manager, told *BM/E* that the station's investment in weather equipment amounts to half a million dollars. KSTP employs nine meteorologists who are on-board 24 hours a day, seven days a week. Their Weathermation system allows the meteorologists to dial-up National Weather Service radar sites across the country. Raw radar data is computerized and colorized to create a wide assortment of user programmed displays. In addition, computer graphics can be superimposed for special effects.

At WBBM-TV in Chicago, Harry Volkman uses two Weatherscan interactive terminals to dial up the National Weather Service/Federal Aviation Administration circuit. One terminal is at Volkman's home, the other at WBBM. His terminals connect directly into the Weatherscan computer in Oklahoma City via phone line. Data on highest and lowest temperatures, deepest snow, cold and warm fronts, winds over 40 mph, or heaviest rainfall can be obtained. Volkman also interfaces with the National Wea-

ther Service radar at Marseilles, Ill. This arrangement represents a middle course.

At the low price end, cable TV operators connect character generators, such as those made by the Beston Co., to simple weather data acquisition instruments. At the other end of the scale, some CATV operators have a huge investment in providing weather services. One example of this is meteorologist Dallas Raines of Ted Turner's Cable News Network, WTBS, in Atlanta. Raines does six weathercasts daily using a variety of weather systems, including Weatherscan and the Alden satellite receiver, which shows isometric fronts and upper atmospheric pressure. He also uses Weathermation's system, providing animated displays generated by National Weather Service radars.

Dialup radar services

Buying your own radar system with high penetration capability could require an investment of \$200,000 including installation. Even with this expenditure, the radar data is only useful to the meteorologist, who must interpret data for audience consumption. For less than one-third of the buy-your-own investment, a TV station can buy a dialup radar system. These systems provide colorized, computerized displays based on access to radar site data. Using computer graphic techniques, the user can depict boundaries, simulate animation, and produce special effects.

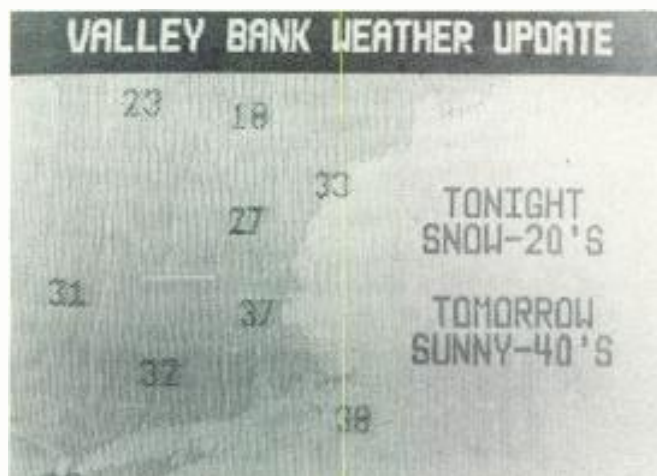

Raw weather data has been processed by Weather Services International so that the local temperature appears on the display. The forecast and state boundaries are seen

At HVS, one great TBC always leads to another

In this case, it's the new HVS 590, a true state-of-the-art, digital TBC that handles virtually every type of VTR, from portables to the latest broadcast types.

Since we introduced the first commercial digital TBC as CVS in 1972, we've constantly added improvements as the needs of the video industry have changed. And now as Harris Video Systems, we introduce the 590. The most useful and technically advanced model yet.

On the one hand, it's ideal for ENG and EFP. Features like a 16 line window and automatic vertical centering, plus line-by-line velocity compensation, make it even easier for you to cope with portable VTR gyro errors, random edits and other daily disasters.

At the other end of the spectrum, the HVS 590 also creates better results with broadcast VTRs because it

has, as standard equipment, dropout compensation and variable H blanking. The HVS 590 also:

- Dubs cassette and other non-capstan servo'd heterodyne VTRs up to production machines, like quads and "C" format.
- Converts all heterodyne VTRs to phased color for transparent playback resolution.
- Uses advanced 9-bit, 4-times subcarrier PCM digital sampling to ensure excellent picture quality, even on multi-generation tapes.

So, to handle just about any signal processing job you have — and any VTR — get the HVS 590, a great TBC in a long line of great TBCs!

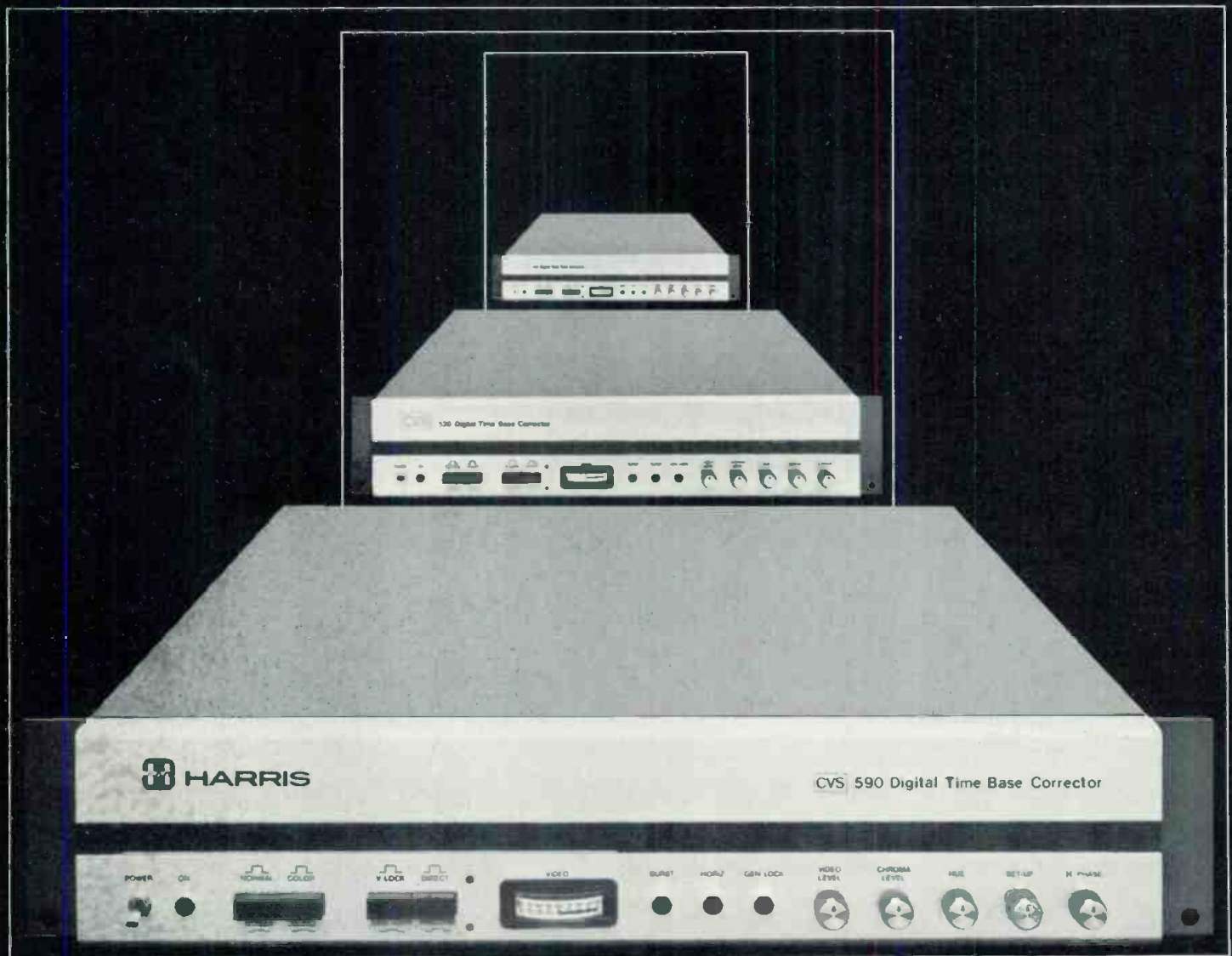

SEE US SMPTE BOOTHS #5 & 6

HARRIS



COMMUNICATION AND
INFORMATION PROCESSING

HARRIS CORPORATION Harris Video Systems
1255 East Arques Avenue Sunnyvale, CA 94086 (408) 737-2100

Circle 151 on Reader Service Card

EWG: Electronic Weather Gathering

Raw radar data is collected from data transmitters located at National Weather Service radar sites throughout the U.S.A. NWS presently has 117 sites and is adding about 10 each year, including one in San Juan this spring. As of August, 1980, NOAA reported that four companies had installed data transmitters at a number of their radar sites. These are Weathermation, Enterprise Electronics, TSC Development Labs, and Arvin. Weather radars allow a maximum of one echo reading per degree of rotational scan. As three scans occur a minute, a maximum of 1080 (360 times three) readings can be taken each minute. Displays can be updated from 24 seconds to 100 seconds, depending on the design of the data transmitter. Additional angular position readings are also obtained.

Chicago-based Weathermation provides dialup radar data, offering access to any of four predetermined radar sites. A user merely punches a site code on a terminal keyboard to obtain site data. For example, punching OKC will key in an NOAA radar in Oklahoma City. With four available sites, a user can track a hurricane in the Gulf, a snow storm in the north, a rain shower in the west, and a hail storm in the east — all at the same time. Each radar site has a range of 60 to 240 nautical miles.

Weathermation employs four separate memory banks for individual site data storage. Freeze frame holds an image indefinitely, updating it for instant echo motion or time lapse analysis. A solitary storm cell can be highlighted, and any combination of six rainfall rates can have their own colors. Light, moderate, and heavy precipitation are colored blue, green, and light green, while very heavy, intense, and extreme precipitation are colored yellow, orange, and red. NTSC video output can feed a monitor, video switcher, or video disc-cassette for animation. Weathermation's computer graphics option allows special effects to be created. Customized maps, grids, and alphanumeric characters can be superimposed over the radar image. A standalone character generating system can also be used. Displays appear instantaneously, or in animated sequence via memory storage.

Enterprise Electronics Corp., in Enterprise, Ala., is a leading manufacturer of radar equipment for the National Weather Service. EEC also provides a dialup service from their data transmitters located at 80 NWS radar sites. Data is transmitted with a digital clock readout showing the time the radar scan was last made and the radar antenna elevation. At long distances, thunderstorms or snowstorms may go undetected if the antenna elevation is too high. Precipitation levels each have a unique color, and geographical overlays are produced. Video output is NTSC. EEC uses a digital video processor to provide digital or analog format and six preset rainfall rate ranges. Processor output may be stored on magnetic tape for future analysis or processed in real time.

TSC Development Laboratories of Santa Monica, Calif., offers a radar site dialup service. Ray Durand, general manager of TSC, told *BM/E* that color is fully adjustable and a two-color background is available. Durand explained that customers own their own site data transmitters, so there are no network lease charges. A remote control panel allows control of up to nine quadrants. This large quadrant offset capability permits users to have their own station exactly in the center of the radar scan display. Also, a four-to-one area expansion, or two-

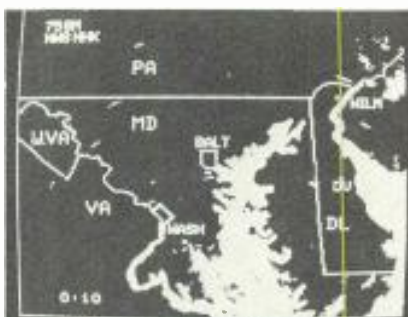
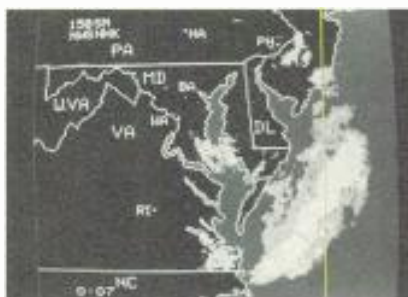

Pictures to the left, supplied by Technology Service Corp., show three of four range scales from a single NWS radar site. The top two pictures are centered on the NWS Patuxent, Md. radar and show a large storm off the coast on the 150-mile radar range

The two pictures on the left are NWS radar sites centered on Baltimore, Md. and Washington, D.C. The radar range in these displays is only 75 miles

to-one zoom, is standard. Map overlays, symbols, or user-generated logos can also be sent.

Arvin Applied Technology Group, in Carroll, Ohio, calls its dialup weather radar system Tel-Weather. TV pictures identify cities and geographical features and show circles indicating maximum radar ranges. An optional character generator permits adding supplementary data to the map. Weather maps are continuously updated until the phone is disconnected. At that time, the last map is stored in memory. Four-color NTSC video can be fed to monitors or modulators. A quadrant selector-enlarger allows one quadrant to be enlarged to full frame.

In Ontario, Canada, Goodwood Data Ltd. provides dialup radar services to Canadian users. Dave Butler, general manager, told *BM/E* that he will supply computer processors for existing radars or a complete radar and image processor package. Goodwood's radar gear is made by Vitro Services, Ft. Walton Beach, Fla. The system displays a three-dimensional picture providing current weather and a three-hour forecast. Butler claims his system can give a three-hour tornado warning due to sophisticated image-processing techniques. He plans to hook up with FAA's developmental radar, NEX RAD, which

"For the best national and local radar coverage, I depend on Weathermation."

Why does KSTP, one of the country's largest and best equipped weather facilities, count on WEATHERMATION Color Remote Radar? Perhaps it's because WEATHERMATION has the most far-reaching dial up system in the industry, with more digital transmitters at more sites than any other system. Perhaps it's because only WEATHERMATION provides simple telephone access to over 120 radar pictures. Or maybe it's because WEATHERMATION is the most cost-effective system on the market today; as new sites are added, they become available immediately to all WEATHERMATION owners, complete with map overlays at no extra charge.

At KSTP nine professional meteorologists work 24 hours a day, seven days a week to provide their radio and television audiences with over 200 weather reports a week. "Country Day," KSTP's syndicated early morning TV show broadcast by 30 stations reaching 13 states each day, relies heavily on WEATHERMATION for up-to-the-minute weather information.

So, when timely accurate weather news counts, take the word of the pros. WEATHERMATION.

*Dennis Feltgen, Director
Eyewitness News Meteorology
KSTP Channel 5, Minneapolis*

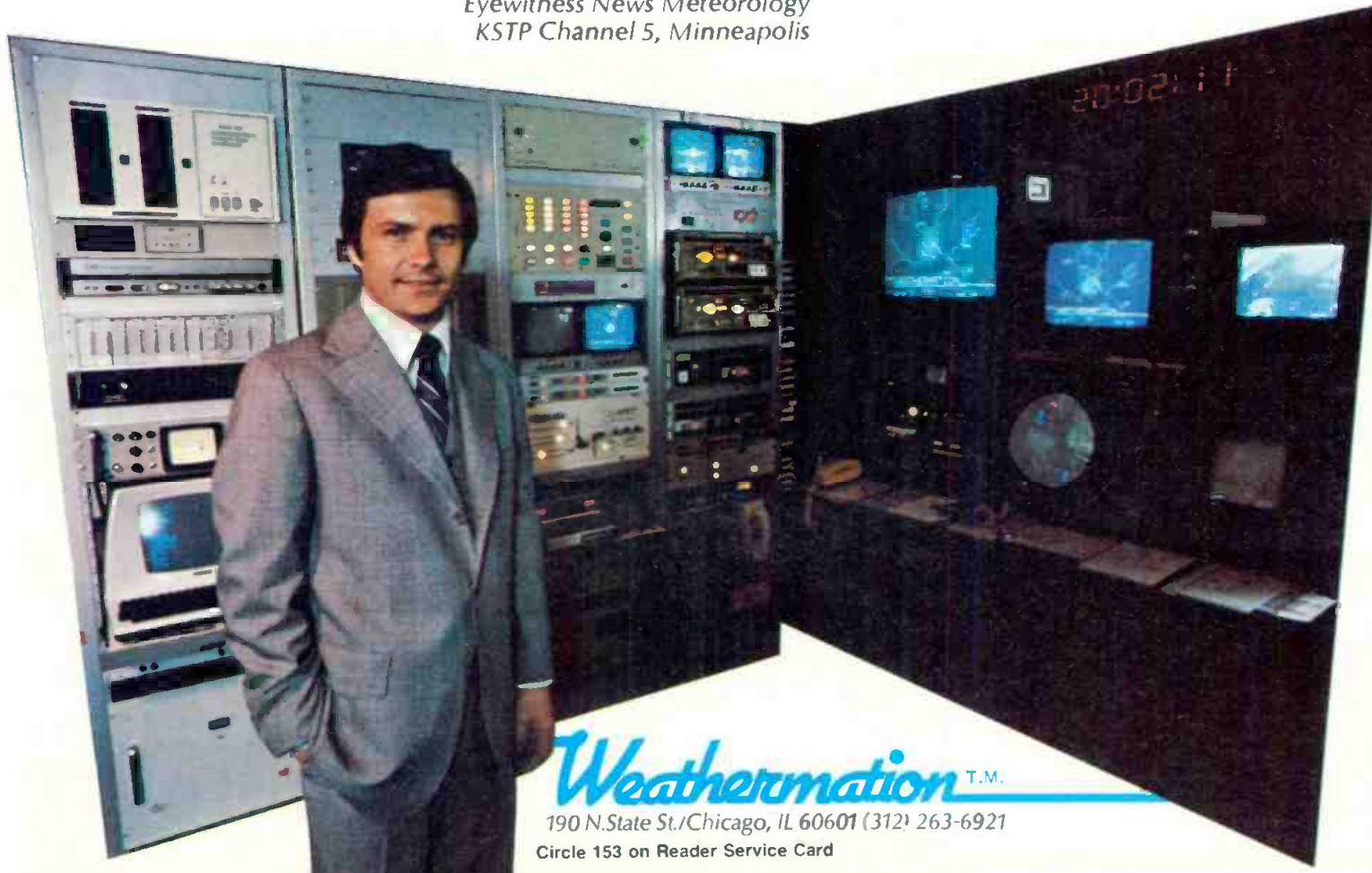

Weathermation T.M.

190 N.State St./Chicago, IL 60601 (312) 263-6921

Circle 153 on Reader Service Card

EWG: Electronic Weather Gathering

should be operational in the U.S. in five years.

Other dialup services

Located in Oklahoma City, the Weatherscan database assembles data from the Federal Aviation's "604" weather circuit. This includes weather reports from more than 2000 weather stations around the world. Data formats are designed for either seasoned meteorologists or the general weathercaster. Weatherscan creates weather maps that show high and low temperatures, current temperature, and dew point. Maps also show precipitation, including freezing, and current rainfall. Additional displays depict wind speed, visibility, and snow cover.

A user can key in 4096 colors on Weatherscan's Hewlett-Packard "L" series computer. Video output is RGB for use with TV station encoders, or NTSC, which is compatible with other video sources. Output may be chroma keyed, superimposed, or displayed full-screen. Logos or preprogrammed characters may be added. Computer graphics maps are available with sequenced still frames for animation. Background colors can be set, connecting line segments, and rectangles can be drawn.

Weather Services International, in Bedford, Mass., provides a dialup CRT or printer terminal. Alphanumeric weather data is received from 4000 stations including the National Weather Service Corps of Engineers, the Coast Guard, and the Global Telecommunications System. WSI keys into RAWARC, the five regional radar storm warning circuits. Real-time display and storage up to months is available. Using alphanumeric characters, upper atmospheric maps may be plotted. Local numbers can be dialed to request a data reply. Pete Leavitt, WSI president, told *BM/E* that outdated teletype terminals required time-consuming surveillance. WSI allows the weathercaster to access a prepared program routine. For example, an access code will display weather all along a major interstate highway, or whatever is user-significant.

Alden provides graphic facsimile data with its recorder, which receives National Weather Service data from Suitland, Md. Users receive NAFAX (analog) or DIFAX (digital) data, providing information for the U.S., over-

seas, and atmospherics. Data is updated every six hours.

User-owned radar transmitter

Although dialup radar services provide a great deal of flexibility in programming, some TV stations prefer to observe approaching storms and tornados on their own radar equipment. Weather radar is made by Enterprise Electronics, RCA, Raytheon, and Vitro Services. As a general rule, the lower the radar wavelength, the greater the radar's ability to penetrate rain. Therefore, S band radar (2.7 GHz) with 450 kW output will have the greatest rain penetration capability. Next is C band radar (5.5 GHz). Both S and C band radar have a typical range of 300 miles. X band radar (9.3 GHz) is priced at about 60 percent of S band radar and is thus used where economy is the greatest consideration. Its range, however, is less than 150 miles.

The most recent advance in radar technology is Doppler radar. This equipment operates on the principle that target movement can be calculated by measuring the Doppler frequency shift of the returning echo. KSTP in Minneapolis is the first TV station in the country to have ordered a Doppler radar. According to KSTP meteorologist John Dooley, Doppler radar will permit the station to see raindrop motion, and the movement of thunderstorms and tornados before the vortex has even dropped out of the clouds. This will facilitate a 20-minute tornado warning time, which can have life-saving implications. Doppler radar will also show air mass movement.

One kind of radar now on the drawing board is Proportional radar. Two different wavelengths are transmitted at different antenna elevation angles. A proportional analysis of the echoes indicates differing conditions at various atmospheric levels.

Satellite weather data

NOAA has launched three Geostationary Operational Environmental Satellites (GOES), covering the eastern, central, and western U.S., respectively. All three are located over the equator. Each takes 24 pictures in both the visible and infrared range. NOAA receives the raw, line-by-line data, programs it, and sends it back to another transponder on the same satellite. It is then retransmitted with coastal outlines and state boundaries. NOAA re-

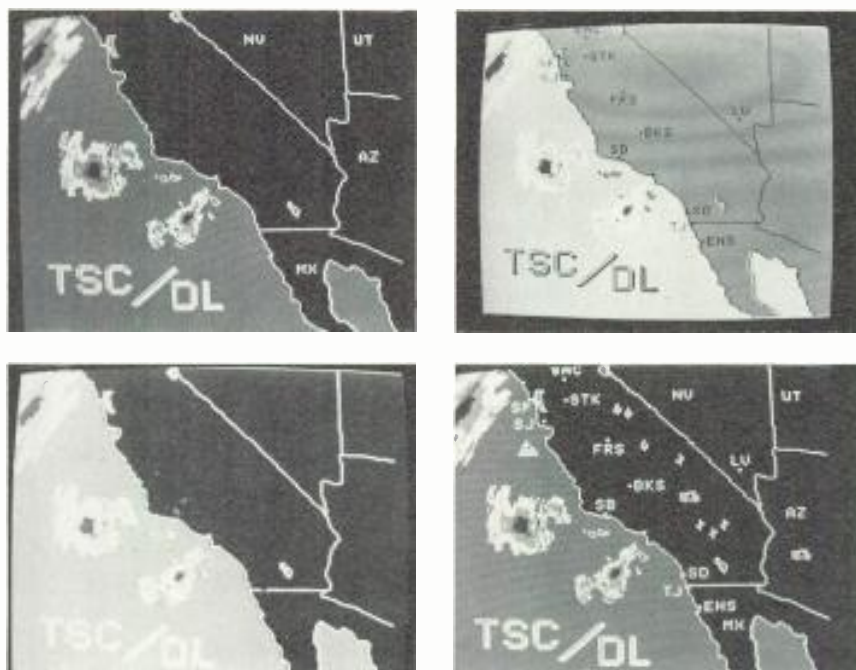

The group of radar displays to the left, also from TSC, shows simulated rain off the coast of California on a 300-mile radar range. Top left shows state outlines with state abbreviations. Top right has city abbreviations. Bottom left has only state boundaries, and bottom right has city and state abbreviations

EWG: Electronic Weather Gathering

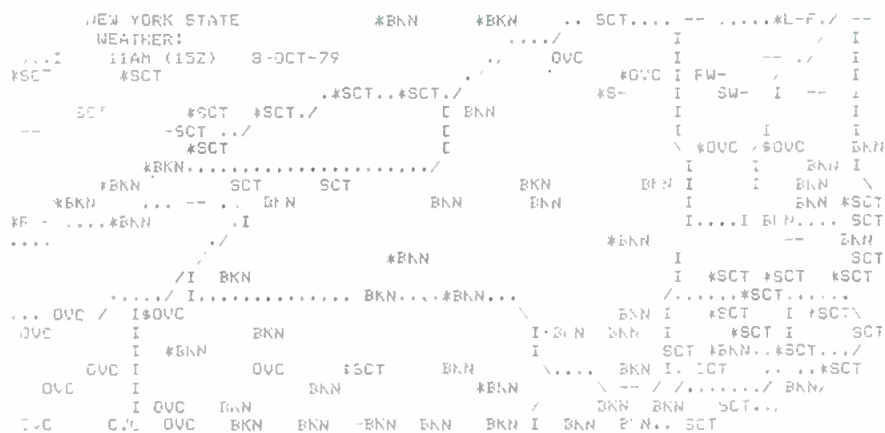

WSI provided this alphanumeric map. The abbreviations depict overcast, scattered and broken cloud conditions over New York state

ceives this reconstituted data on S band, sending it via UPI facsimile to over 56 data distribution centers in the U.S. TV stations can subscribe to this data at the monthly rate of \$2 per mile. Data received from primary centers in Washington, Miami, San Francisco, Kansas City, or Louisiana, offer the TV station a full menu with a choice of 24 sector views and full capability. TV stations may receive data from the secondary centers (approximately one per state) to save mileage charges. However, the menu is sharply limited from secondary data distribution centers. The broadcaster is limited to the data which is sent to the local weather service. A local sector with a periodic large-scale map is sent. There is little flexibility in zooming in to the satellite's ultimate visible resolution of one-half square mile, or its infrared resolution of two to four miles.

Gulf Weather Services in Florida employs an S band receiver to access GOES East directly, without subscribing to NOAA's facsimile data distribution landline. Environmental Satellite Data in Columbia, Md., is planning to offer a similar service. Terry Hambrick, general manager, told *BM/E* that ESD will send data over commercial data circuits using a digital TV raster format. User display terminals will show animated sequences, superimposed graphics, and political boundaries. According to Hambrick, the ESD system resolution will be improved over NOAA's facsimile line by a factor of two to one. He stated

that image intensity will be improved by a factor of two for visible images, and by a factor of eight for infrared images, and that boundaries will be more precisely aligned. He also noted that digital data transmission will allow use of a variety of peripheral display devices.

Information Processing Systems, in San Francisco, makes an analog videodisc recorder. The IPS recorder receives satellite data from NOAA's facsimile landline. Larry Niswander, general manager of IPS, told *BM/E* that the IPS disc recorder eliminates degraded picture resolution, which is caused when a picture is taken off the Unifax. This is done by converting a Unifax signal to analog and displaying it directly in NTSC 484-line color. Using the IPS Colorgraphics system, the user can change the colors for land, water, or clouds, program zoom in, or add geographical boundaries, logos, or additional characters. The weathercaster presses a keyboard button to enter the complete graphics program. Niswander stressed that digital bit depth is the key to high color luminance. He claims most data processing techniques use only four-bit digital depth producing flat, faded color, while IPS Colorgraphics uses eight-bit digital depth.

Arvin provides pictures taken from NOAA's GOES satellites, colorized so that clouds are white, water blue, and land green. A 200 frame storage disc permits storms to be animated and displayed as live movement. Memory recall determines the animation speed.

Goodwill Data, in Ontario, Canada, also processes data from GOES satellites. Data techniques analyze satellite cloud pictures to detect whether rain is coming from that particular cloud. Satellite and radar data are compared to insure that both data sources are in agreement where there is overlap.

What next

Fifty years ago a renowned meteorologist said, "give me enough data and I'll forecast the weather perfectly every time." If he were alive today, he would be delighted. Weather data acquisition techniques are proceeding at an accelerated pace. Weather satellites are being deployed internationally. New radar systems will be furnishing data never before available. Computer hardware and software is becoming so sophisticated that TV stations can access only the most relevant, real-time weather data. Graphic animation techniques are developing to the point where stimulating graphics will excite the TV viewer, while at the same time having serious forecasting value. Combining all these innovations, weather reporting is fast becoming a vital part of TV station operation.

BM/E



In the above photograph, the operator is seen dialing up a radar weather display on Weatheration's computer graphics system. A custom map is seen superimposed over the radar display

TSC WEATHER RADAR

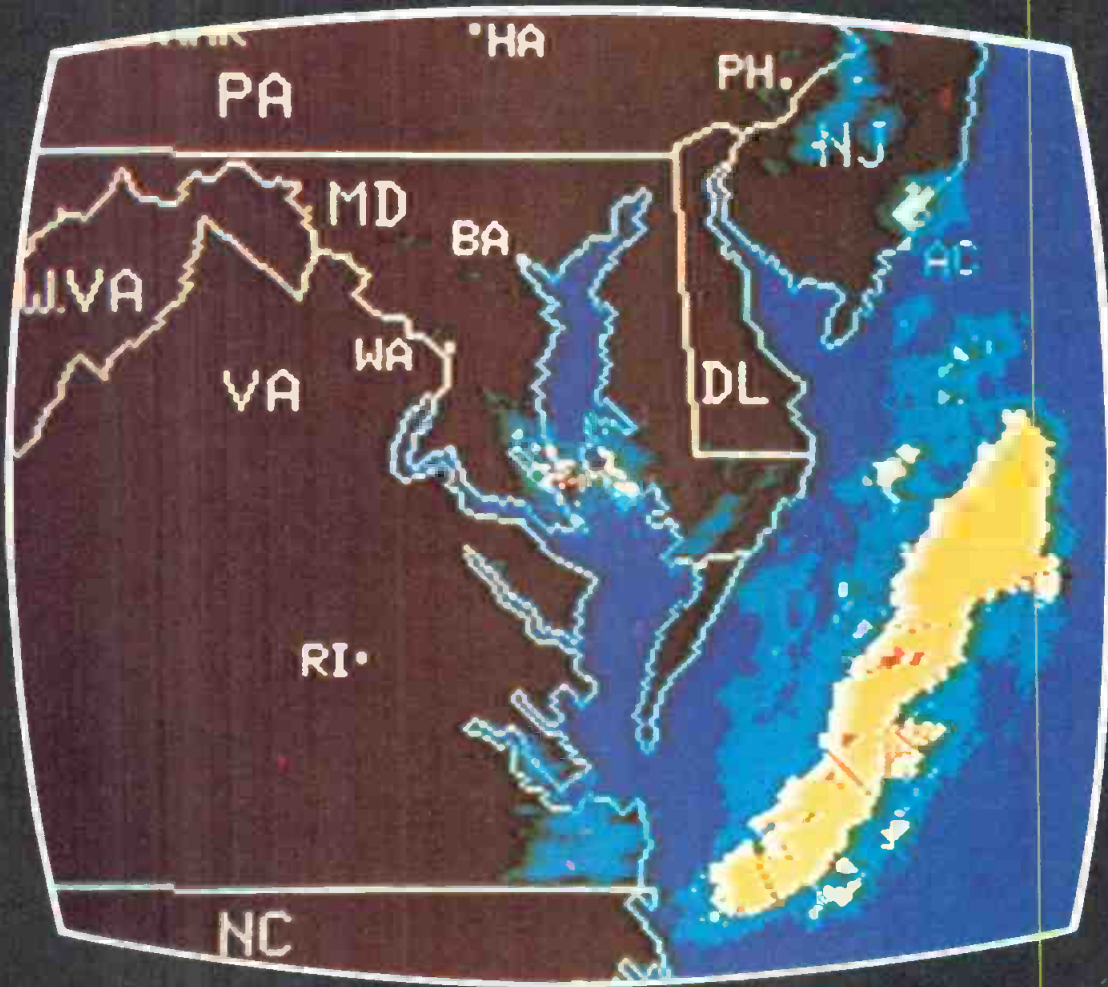

FROM NATIONAL WEATHER SERVICE
DIAL-UP REMOTES TO
LIVE WEATHER RADAR SYSTEMS

WE'VE GOT IT ALL!

- 9 Quadrant Sector Zoom • 2 Color Background
- Sweep Line • Animated Graphics
- Fully Adjustable Colors • Maps Transmitted with Picture
- Custom Map Overlays • Screen Filling Display
- Display Centering for Your Location
- No Recurring Network Charges • Interface to Any Weather Radar • Remote Control Panel

SEE US AT NAB



TECHNOLOGY SERVICE CORPORATION

2950 THIRTY FIRST STREET, SANTA MONICA, CA 90405 • (213) 450-9755

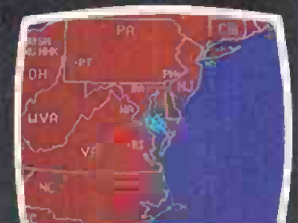
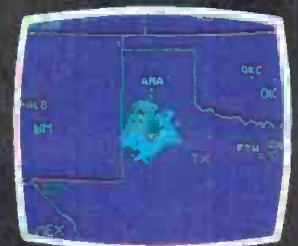
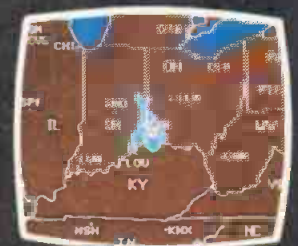
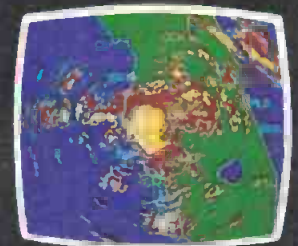
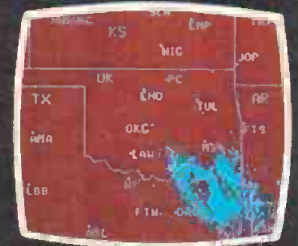
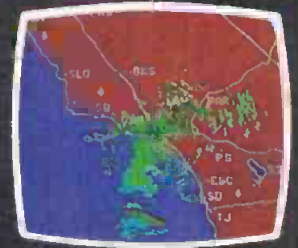

EIMAC's new high-mu triode/cavity combination. It takes the hassle out of 10 kW VHF transmitter design.

Relax. Now EIMAC offers you the best triode available and a cavity that has been custom designed for it. All you have to do is design them in.

The advantages are impressive. EIMAC's ceramic-metal high-mu triode (3CX10000U7) gives you peak sync power output of 10 kW and a stage gain of 14 dB. That's 2 dB more than with comparable tetrodes.

And there's more. Driving requirements are reduced; screen power supply and screen circuitry are eliminated; and cooling requirements are lessened. The result is ease of maintenance and substantial cost reduction.

There are two EIMAC cavities for your 10 kW combination, the CV-2240 for channels 2-6, and the CV-2250 for channels 7-13. For further information contact Varian, EIMAC Division, 301 Industrial Way, San Carlos, California 94070, (415) 592-1221. Or call any of the more than 30 Varian Electron Device Group Sales Offices throughout the world.



Circle 154 on Reader Service Card

SMPTE: No Surprises, But Solid Progress In Digital

THE 122ND TECHNICAL CONFERENCE OF the SMPTE took nearly five full days to complete, but aside from the sessions on digital technology, RS-170A, and the introduction of a few new products from some of the more than 150 exhibitors (see SMPTE product news following this story), little new was generated. Obviously, the organization has had its share of problems as the exhibit side of the conference grows more important.

There was some grumbling among exhibitors over too short a setup time and electrical snafus at the New York Hilton Hotel, though they were generally pleased by the amount of traffic. Delegates to the conference were happy with the exhibits but found the papers sessions largely to be made up of historical perspectives on various film and television technologies, adding little new to their body of knowledge. There were exceptions, of course, especially those papers dealing with digital subjects and a few occasions where strong efforts on the part of session chairmen to stimulate open discussion raised the level of the discourse measurably.

Eugene Leonard of DaVinci Research Group, session chairman for Wednesday's afternoon "Problems of Maintenance" segment, gathered together a remarkable group of authors to address the subject of current and emerging problems presented to television facilities engineers by the newer technologies. Though the papers and the panel discussion that followed provided some of the high points in the conference, the effort fell short of its intended target because Leonard's original plans to stimulate attendance and encourage participation got sidetracked.

Leonard had hoped to distribute preprints of the papers to delegates so that they could be prepared to discuss the issues raised by the authors and participate more fully in the panel discussion. SMPTE, however, changed direction several times regarding Leonard's plans and ended up calling a halt to further distribution of the copies that Leonard had made. "What became clear," said Leonard, "was that they [SMPTE] apparently had no policy to handle this sort of thing. A principal objection raised to the preprint was a paragraph that cited System Concepts and Studio Film & Tape, Inc. for their cooperation in making the papers available. Apparently, it was thought the paragraph was worded in such a way



Fred Remley delivered a brilliant paper outlining the march toward digital television

that readers might construe that the session was sponsored by these companies. Since commercial sponsorship of technical papers or sessions would clearly violate SMPTE policy, it was determined that the distribution of the preprints should cease unless the offending paragraph could be removed.

According to SMPTE president Robert Smith, the decision to pull the preprints was made after consulting with SMPTE attorneys. Smith said, however, that the society had no interest in preventing the distribution of such preprints, though it does have a vested interest in preserving any SMPTE copyright for its journal. Said Smith, "We reserve the rights because we want first shot at printing it in the *Journal*."

Smith agreed, on the other hand, that the question of preprints or some form of publicity for upcoming papers was worthy of consideration by the SMPTE's board of governors. Smith noted that some organizations insist on publishing papers prior to their formal delivery. This process often helps to improve the quality of question and answer periods since the audience can be more thoughtful regarding the subject matter of the paper, having already read it. SMPTE's only concern, said Smith, would be that any preprint be exactly as the paper actually delivered so that no commercialization or hedging could be introduced that might affect the credibility of the society.

At the recent IBC in Brighton, U.K. (see *BM/E*, November, 1980) the full

papers of each contributing author were published in advance of the conference. Often, authors were able to skim over long or complicated sections of their papers and simply refer delegates to the full text. Not only was time saved, but the general level of the question and answer period following the papers seemed more fruitful.

Nevertheless, the session on "Problems of Maintenance" did shed some light on the concerns the industry has as we move into the digital era. More on this later. The other important sessions at the Technical Conference included the Wednesday afternoon session on "Computer Graphics" and the Friday morning session on "Digital Television."

Digital era pushing closer

Fred Remley, technical director, Media Resources Center, University of Michigan, presented a brilliantly organized paper providing the first clearly reasoned assessment of issues concerning digital video equipment. The purpose of the paper, said Remley, was to "outline some of the important needs that must be met on behalf of the television industry to allow the technology of the 80s, the era optimistically dubbed 'The Digital Decade,' to proceed smoothly into reality."

Remley reasoned that the great strides made in the quality of analog video both in terms of production equipment and home receivers, coupled with the fact of millions of receivers already in the hands of consumers, suggests that further quality improvements through digital techniques might not be the prime motivating force behind the drive towards digital television. While further improvements are desirable and may be needed in video technologies other than broadcasting, several other considerations are far more pressing, Remley said.

Among those cited by Remley were the need for new studio production advantages (i.e., multi-generation copies without degradation) and the sheer fact that equipment designers seem to like working with digital circuits and are gaining access continuously to ever superior semiconductor components. A switchover from analog to digital television could solve a number of problems associated with 625- and 525-line television systems. Enhancement of program exchange between countries on different systems and solving the standards problems existing in Europe



EDITING EXPERIENCE

Experience and innovation won us the 1980 EMMY Award Citation for "Outstanding Achievement in Engineering Development" from the Academy of Television Arts and Sciences. We invented the World's first Joystick editor in 1975, and we've maintained our leadership in editing technology. Why? Because editing equipment has been our only product. And this concentrated editing experience is really evident in our computer-based ECS-100 Series editing systems.

All three multisource ECS-100 models offer powerful, precise editing with Standard features such as joystick cruise control and high speed search; auto tag; automatic dialog replacement; auto scene list, store, and recall; and computerized 4 field colour framing — All at a very affordable price. ECS-100 Series systems offer control track or SMPTE/EBU time code, and are compatible with most current VTR/ATR models. Interfaces are available for Type B & C, 3/4" or 1", U-Matic and Audio Tape Recorders.

You can't afford to overlook our experience! Contact us for further information and a hands-on demonstration.

- 1641 McGaw, Irvine, CA 92714, U.S.A., 714-549-3146, TWX: 910-595-2573

**CONVERGENCE
CORPORATION**

For information circle 183 on Reader Service Card

For demonstration circle 184 on Reader Service Card

was another major goal noted.

The existence of a continent split between PAL and SECAM represents a serious impediment to the development of the Eurovision network. Many other reasons exist for the drive toward a digital television system and combined with those outlined in the paper will surely thrust the industry, sooner or later, into the digital television era.

Remley then outlined some of the choices facing various deliberative bodies here, in Europe, and in Japan as they attempt to arrive at a common vision of the digital era. For different reasons both the NTSC and PAL/SECAM worlds have moved toward the notion of component encoding. While Europe has focused largely on the issue of transmission in the network sense and America has hoped for more efficient studio production through digital video, both have found common ground around component encoding, although they differ on sampling frequency.

A variety of choices

While Europe is narrowing in on a 12-4-4 scheme in which Y is sampled at 12 MHz, R-Y at 4 MHz, and B-Y at 4 MHz, recent thinking in the U.S. is leaning towards 14-7-7. Both schemes have their advantages and disadvantages. For example, 12-4-4 has some limited problems with high quality chromakeying, though they seem solvable, and 14-7-7 would lead to very high bit rates, possibly presenting cost control problems. Both have some advantages in terms of suitability for solving 625/525 conversion problems. However, 14-7-7 has some definite quality advantages and European thinking seems to be coming around to the notion that a sampling frequency somewhat higher than 12-4-4 might be needed.

According to Remley, the interesting concept of digital hierarchies, which has arisen in the past year, holds out a substantial hope that a scheme can be developed that would not only solve the matter of international program exchange, but also present a way of extending digital recording to such applications as ENG and EFP, and eventually encompass such superior display technologies as high-definition television.

"The idea is simple," said Remley: "since high digital sampling frequencies produce high picture quality, but may result in expensive and perhaps bulky equipment, what is to be done for applications such as ENG and EFP? Why not consider a submultiple of studio sampling frequencies for such

applications, perhaps using frequencies like 12-3-3 or 14-3.5-3.5, and thus lower the total bit rate? At the other extreme, some users might be willing to pay the cost for what is essentially an RGB digital system, using sampling frequencies of 12-12-12 or 14-14-14."

Remley noted that the notion of digital hierarchies has not made the selection of a sampling frequency any easier. It does help, however, since it makes an evolutionary approach seem more reasonable. That is, it offers a way of starting out with lower sampling rates and working up from there.

As far as the digital VTR is concerned, Remley points out that present technology seems quite capable of producing a 12-4-4 machine but that with current video head design, tracking limitations, and problems created for digital systems by a picture in shuttle mode, a 14-7-7 "will not come easily" to design engineers, at least not at a cost that will live up to the best hopes of the television production industry.

Remley pointed out that much work goes on both here and abroad toward the development of a digital television age. Said Remley, "The situation may not be exactly chaotic, but it is far from being clearly defined."

Definition in the works

Two other papers, however, did show some progress toward "definition." Frank Davidoff of Frank Davidoff, Inc., formerly with CBS, reported that the SMPTE Task Force on Component Digital Coding has organized a demonstration under the chairmanship of Ken Davies for February 2 through 5 in San Francisco that will show video recording using a variety of schemes. DVRs will be demonstrated at packing densities of 768, 712, and 864; chromakey will be shown; picture expansion and an NTSC analog/digital interface will be demonstrated. Picture quality in digital hierarchies will also be demonstrated with chroma/luminance ratios of 4-4-4, 4-2-2, 4-1-1, and 2-1-1. It is expected, according to Davidoff, that these demonstrations will provide a solid technical basis for the selection of digital specifications that will "affect television program production for the next few decades."

William G. Connolly of CBS reported on the progress of SMPTE's Study Group on Digital Television Tape Recording. After updating the results of the committee's "User Survey — 1980" (reported in *BM/E*'s November, 1980, review of IBC), Connolly noted that the committee gave special consideration to the need for a worldwide compatible digital standard and so has turned its attention to the use of a hierarchy of digital codes in component coding form. Since the study



Lenco's Videoscope provides a simple and effective way to assure RS-170A compliance

group is not charged to set up standards *per se*, but rather to explore recording concepts that might lead to standards, it has suggested a hierarchical scheme in which the sampling frequency is designated S. In its highest form the chroma/luminance ratio would be S:S:S, equivalent to R/G/B recording at a bandwidth equal to the highest quality available now or in the near future from the best studio color camera. A descending hierarchy might be S:S/2:S/2, or S:S/4:S/4 or for ENG, S/2:S/4:S/4.

Two proposals for implementing RS-170A

The EIA RS-170A Video Line Output specification has shown the way to resolving phase relationship problems, but as both Bruce Blair of Lenco, Inc., and Charles Spicer of NBC pointed out in their papers, some fundamental problems remain.

Blair's paper described a new Lenco product, Videoscope. While the definition of the correct SCH phase relationship is clearly set forth by RS-170A, a number of problems have made it all but impossible to monitor it, measure it, or correct it. With the Videoscope, however, phasing and timing information is translated into video information that can be viewed on a standard television monitor. Once SCH phase is achieved at the source to which all other sources should be matched, it can be displayed on a monitor and each subsequent source can then be brought onto the monitor, one at a time, for comparison and correction side by side with the original signal.

Steve Smith, a television engineering consultant who operates BTC, Inc., told *BM/E* that he had seen medium-sized television plants brought totally into correct phase within one to two hours using the Videoscope.

Charles Spicer, NBC, got right to the point of his paper by proposing a way out of the color field identification dilemma. The problem with RS-170A, according to Spicer, is that it doesn't go far enough — that identification of the

24-HR. PROFESSIONAL SERVICE FOR COLLINS & CONTINENTAL AM & FM TRANSMITTERS

Continental Electronics offers parts and engineering service for all Collins AM & FM transmitters.

Whenever you want parts or service for your Collins or Continental equipment, phone our service numbers day or night,

(214) 327-4532 parts

(214) 327-4533 service

Continental Electronics Mfg. Co.
Box 270879; Dallas, Texas 75227
Phone (214) 381-7161
1 kW thru 50 kW AM & FM transmitters and related equipment.

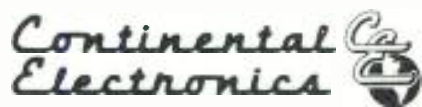

"A New Strength in Radio Broadcasting Equipment"

Circle 156 on Reader Service Card

Don't just sit there
without your

- Time base corrector
- Synchronizer
- Full frame store

RENT

MICROTIME
2525



when and as you need it

Process any video source... synchronize highest quality signals... time-base-correct for both direct and heterodyne VTRs, get full frame freeze for digital effects. Anywhere in the U.S., rent a Microtime 2525 from Miller, featuring Microtime products for immediate delivery, including the #2020 and #1700.



**L. MATTHEW MILLER
Associates Ltd.**

Suite 1316, 205 East 42nd St., New York, NY 10017
Telephones: (212) 687-1168 • (800) 223-0620

Circle 157 on Reader Service Card

NEWS FEATURE

four color fields is still open to confusion.

Spicer proposed a method of color field identification and described its benefits. Though color frame VTRs can eliminate the problem of locking onto the wrong field, they do not solve the problem of random SCH error. Moreover, the VTR is only one of several possible sources of such errors. Therefore, argues Spicer, some method needs to be developed that will allow all elements in a television plant to obtain proper SCH.

The method Spicer proposed begins with the ability to identify the fields before system phase is adjusted. A burst of subcarrier is injected preceding the sync pulse of line 10 of fields 2 and 3. The burst is nine cycles wide and ends two cycles before the leading edge of sync, resulting in a front porch breezeway equal to the back porch breezeway.

Once this is done, it is possible to observe the proper SCH on a waveform monitor set up to isolate the color field ID. Fields 2 and 3 were chosen because the subcarrier crossings for both these fields are the same and field recognition and SCH adjustment can be made in either field.

Spicer urged the industry to demand such color field identification capability in all its sync generators and to demand that all video sources should insert such an ID in their output and that video processing equipment be capable of recognizing the ID and include it in their output.

Reaction among the audience was strong. Frank Davidoff expressed his concern that such an ID system would still not end color field confusion and suggested that other ways might be more practical. Bob McCall of Vital Industries, who led the SMPTE committee on RS-170A, expressed reservations about the idea but thought it was certainly worth investigation. Some delegates in later conversations suggested that such a scheme might be expensive to carry off and would, in any case, take considerable time to be widely adopted.

Problems of maintenance

While the panels on digital technology held open the promise of more change to come in television sciences, the session on maintenance called for reflection on the progress already wrought and expressed concern that the headlong rush into new technologies was creating a schism between systems relied upon and the ability to maintain them.

Walt Nichols, director of engineer-

ing for KPIX, San Francisco, expressed his concern that the new technology may demand a change in the traditional maintenance manual. When a manufacturer supplies a maintenance manual (and Nichols suggested that in many cases they don't) it is often difficult to use and missing vital information. Moreover, because of the increased reliability of much new hardware, maintenance personnel no longer enjoy the familiarity with the equipment. They often go weeks without tampering or tinkering at all with much of the digital hardware. Another problem noted by Nichols and others on the panel is that software-based systems often arrive with no software listings and many manufacturers are reluctant to supply such listings, voicing concern over proprietary issues.

What is called for, according to Nichols and other members of the panel, is not only more and better diagnostics but perhaps a different approach to manuals altogether. Envisioned is a computerized or videodisc-type manual that would allow the maintenance person to quickly locate answers to specific questions and receive detailed, step-by-step instructions.

The panel was also unanimous in its concern over the decline of skill levels among maintenance personnel, a lack of commitment on the part of managements to seeing that personnel receive training in the new technologies, and the growing scarcity of properly trained technicians.

Besides improved manuals, Nichols, Steve Smith of BTC, Norman Rosenheim of Unitel, and session chairman Gene Leonard all called, in one way or another, for a systems approach to maintenance both from an operational standpoint and from the standpoint of facility design. Smith outlined his system for designing facilities that inculcates the needs of system maintenance right from the beginning. Such an approach avoids the development of congenital maintenance problems. At each of the several stages of Smith's planning process, a careful evaluation is made of all choices, their trade-offs, and ultimate impact.

All panelists, and a representative of Marconi Instruments speaking from the floor, cautioned against the neglect of analog components as larger parts of systems yield to digital hardware. (BME will take up this issue next month when we report on "The Broadcast Plant: From Here to Digital.")

Bob Paulson of AVP Communications summed up the session by saying that "we as users and we as manufacturers are in a quandary." Paulson seemed to imply that the problems of maintenance are, for the foreseeable future, bound to outnumber the remedies. **BM/E**

Happy 25th birthday to video tape
from the people who lit the first candle.

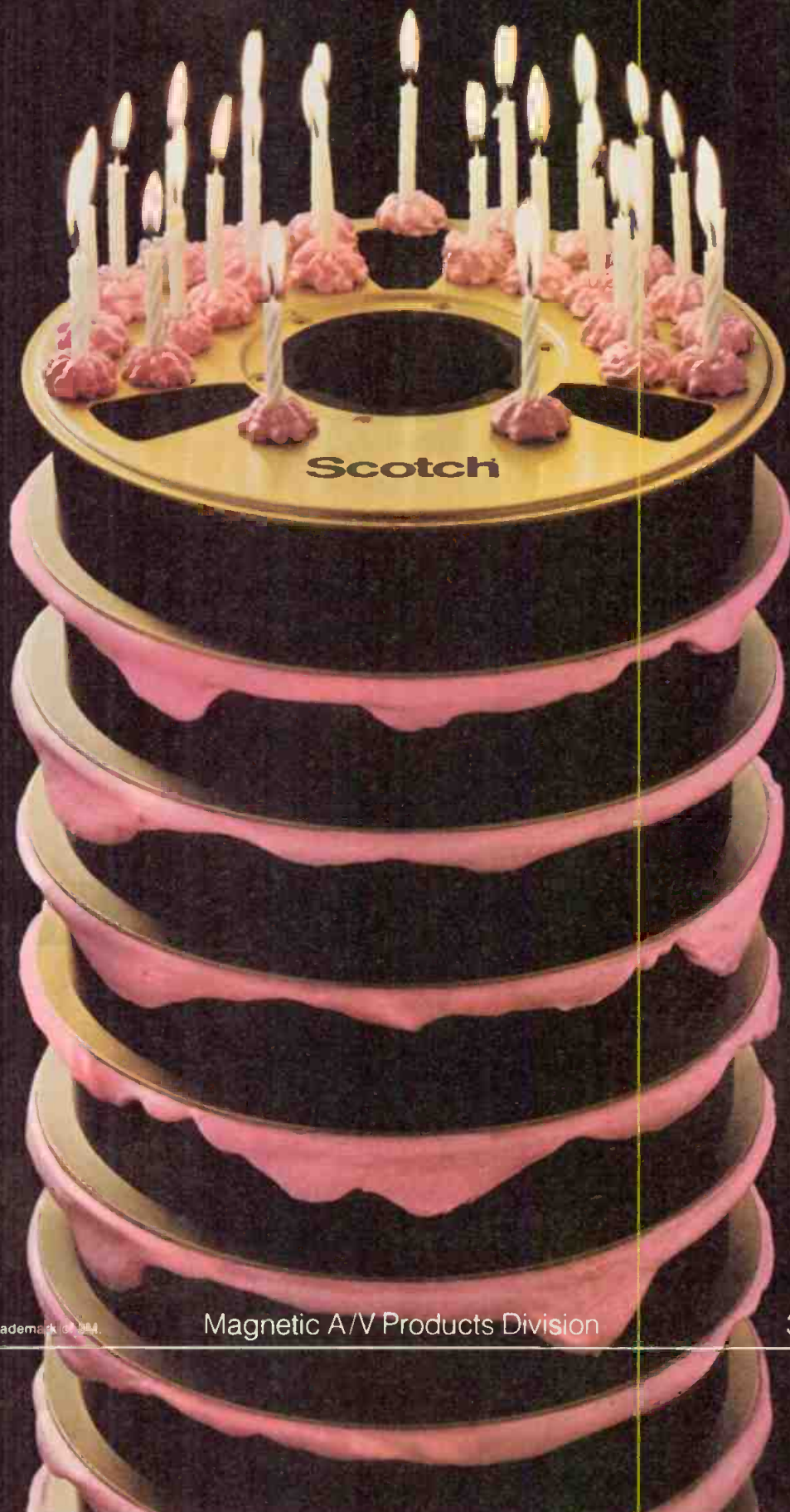

"Scotch" is a registered trademark of 3M.

Magnetic A/V Products Division

3M Hears You.

3M



Beyond ENG

Born into ENG, the HL-79A adapts beautifully to EFP. The accepted leader in ENG, the HL-79A, reinforced its position as the preeminent portable camera at the 1980 Winter Olympics. Scores of HL-79A's covered the ski slopes, the bobsled and luge runs and the skating rinks for the ABC Network. Their performance brilliantly etched into the world's visual memory, is history. But the industry already knows about the HL-79A's capability.

Today, more and more broadcasters are learning that the HL-79A is a superior EFP color camera. Options such as 4½-inch electronic viewfinder with return video, program and intercom audio plus genlock — among other features —

transform it into the ideal camera for sports and special events, commercials and high quality production. Triax equipped, it ranges nearly a mile from its base station. Near-darkness is its frequent habitat; but it has knee control for brilliantly lit scenes too.

Of course, you may need some of its ENG flexibility for EFP too —like its shoulder action shape, 11.2 pound weight, 6-hour clip-on battery.

The specs and automatic features of the HL-79A are equally outstanding. They're yours, along with an eye-opening demonstration, at your Ikegami distributor. Or contact Ikegami Electronics (USA) Inc., 37 Brook Avenue, Maywood,

N.J. 07607, (201) 368-9171. West Coast: 19164 Van Ness Ave., Torrance, CA 90501 (213) 328-2814; Southwest: 330 North Belt East, Suite 228, Houston, TX 77060 (713) 445-0100; Southeast: 552 So. Lee St., Americus, GA 31709 (912) 924-0061.



Ikegami HL-79A

Circle 158 on Reader Service Card

SMPTE Exhibits: Midseason Changes

BROADCASTERS IN the past few years have gone from a single "new season" to a combination of new programs, midseason replacements, and a full second season. Now manufacturers of broadcast equipment seem to have adopted the trend. Where once there was the expected flood of new product introductions at the annual NAB, now new products seem to be appearing regularly at every major industry gathering throughout the year. SMPTE got its share, most notably with the introduction of three brand-new camera systems. RCA showed its TK-86, and Toshiba its PK-60, and CEI introduced its brand-new color studio camera, the Americam.

New editing products, controllers, time code readers, new lighting equipment, telecines, intercoms, machine control systems, still stores, and new test equipment joined the wide array of equipment already available to broadcasters and film makers.

New camera action in the spotlight

Three all-new camera systems made their appearance at SMPTE in New York. The RCA TK-86, heir to the TK-76, was shown in the RCA suite and not in the booth. The CEI Americam, though it was shown at VidExpo, made its debut to the broadcast audience. Toshiba, however, took the wraps off its PK-60 for the first time anywhere.

The new TK-86 is far leaner and less power-hungry than the 76. It has been redesigned to improve balance by lowering the center of gravity and incorporating an improved shoulder mount. The new camera weighs just 14.2 pounds and has considerably smaller outside dimensions than the 76. Power consumption has been brought down to 33 W operating off a 12 V dc source.

Featuring a 54 dB signal-to-noise ratio, the camera also offers a wide variety of electronic circuitry for picture enhancement, comet tail suppression, contrast suppression, and low light level operation. The camera offers both +9 and +18 dB gain modes for shooting in dim light. Either Saticon or Plumbicon tubes can be used. The optic system is a sealed prism and a new Angenieux 15X9 lens is standard. The lens weighs 4.6 pounds and offers f/1.5 at 9 to 100 mm and f/1.9 at 9 to 135 mm.

Toshiba called its new PK-60 the smallest, lightest broadcast-quality color ENG camera anywhere. Priced at \$34,500, the PK-60 weighs just 9.4

pounds and measures 10.4 inches high by 11 inches long by 3.75 inches wide. A variety of Canon and Fujinon zoom lenses are offered as accessories.

Electronically, the camera consumes 20.6 W and operates from a 12 V dc source. Tubes are either Saticons, Plumbicons, or diode gun Plumbicons. Signal-to-noise ratio is better than 54 dB.

Another significant feature of the PK-60 is its automatic digital setup option. Called Digital Data LocTM, it consists of a digital base station or Auto Setup Box and a digital memory adapter for the camera. When the base station is connected to the memory adapter, proper centering, black levels, and white levels are established. After the camera is disconnected from the setup box, these parameters are maintained by the non-volatile memory. The operation takes only a few seconds, so numerous cameras can be set up in sequence or, by using the automatic setup terminals provided on the rear of the digital base station, several cameras can be set up in a chain.

Analog control is standard and provides for triax or multicore cable operation. The camera with the triax connector can also be operated and controlled in a wireless configuration via a microwave link.

CEI took aim at religious and educational broadcast markets as well as the industrial and cable TV markets with the introduction of its Americam. Priced at less than \$30,000, the Americam is a full color studio camera providing a 52 dB signal-to-noise ratio and a host of high-quality features based on the electronics of the CEI 300 series of cameras.

Americam utilizes Saticon, Plumbicon, or diode gun Plumbicon tubes and offers triax operation as well as standard coaxial or multicore operation. The optical system is a bias lighted,



Datatron's Vanguard featured a new SmartScan option

high index glass prism with RGB split. A built-in filter wheel offers cap, 85, 85B/.6ND and clear glass elements. The camera is available in NTSC, PAL-I/B, PAL-M, and SECAM models. The viewfinder is a tiltable five-inch monitor with sun shade.

Other camera innovations

Ikegami showed two new variations of its HL-79, the HL-790A and the HL-79D. The 790A is configured to convert quickly from a studio camera to an ENG camera. The 79D is in the ENG/EFP configuration but will be improved to accept the diode gun and use



Toshiba's new PK-60 camera, its smallest yet

FET preamps. In addition, RF shielding has been improved and dynamic beam focusing offers better corner resolution.

Canon showed a unique camera accessory, the U-1B2 remote control pan-tilt system. Designed for use with a compact color camera, the unit consists of a pan-tilt head, zoom lens, and control units. The unit shown used a J13X9B zoom lens, though other lenses may be specified depending on the camera model.

At the remote control panel up to eight different shots can be memorized. The term CUT is used to describe the transition between shots; cuts are executed automatically after the "change" button is pushed. The travelling time between shots can be trimmed during operation.

Obvious applications for such a system would include simple news programs or segments of more complicated news programs like the weather, or dialogue in a panel program.

Recording and editing

While there were no dramatic advances in recording or editing technology displayed at SMPTE, there was news, including the first U.S. showing of a new two-machine edit controller from Ampex, a new still store from

Lenco's VNM-428B Video Noise Meter ...Only If You *Really* Care About Noise.

NEW



Some people think that video noise is a bore. They just couldn't care less about it. They figure that if they ignore it, it'll go away.

On the other hand, there are some forward-thinking, dedicated video engineers who are vitally concerned about their signal quality.

If you belong to the former group, you can stop reading this ad.

However, if you're interested in making fast, accurate signal-to-noise measurements of *any* composite video signal — no matter what the source — check out our VNM-428B Video Noise Meter.

The VNM-428B is specifically designed for the video S/N measurement requirements of TV studios,

CATV, satellite or microwave systems. It utilizes a tangential noise measurement technique which overcomes the problems associated with oscilloscope measurement of Gaussian noise in video waveforms.

It's a small, rugged and stable unit, with a built-in calibrator that ensures an accuracy of 1% throughout the range of 28.5 to 76 dB. Three precision filters, conforming to EIA/CCIR standards, are built in. The large, easy-to-read LED display can be seen from across the room.

So if you're *really* concerned about video noise, call your nearest Lenco sales office today. We'll be happy to give you a no-obligation demonstration.



Want to know more about noise measurement? Write on your letterhead for a FREE copy of "Television Signal-To-Noise Measurement — A NEW APPROACH".

LENCO, INC., ELECTRONICS DIVISION

300 N. Maryland St., Jackson, MO 63755, (314) 243-3147

REGIONAL OFFICES

1120 S. 4th St., Atchison, KS 66002, (913) 367-1146

5456 Blossom Acres Drive, San Jose, CA 95124, (408) 356-0221

Box 4042, Albany, GA 31706, (912) 436-4927 • 7303 Poplar Lane, Middletown, MD 21769, (301) 371-5588

Circle 159 on Reader Service Card

NEWS FEATURE

ADDA, additional functions in the Datatron Vanguard editing system, a new Dynasciences approach to videotape editing, and another digital video art system, this one to be marketed by Vital.

Dynasciences' new editor, a version of the MS-80, gets very high marks for simplifying the selection of in-points with its new microprocessor control system. The new unit, priced under \$30,000, is a multi-source editor capable of memorizing and executing up to 256 events with an external disc drive option. A, B, and C rolls are accommodated using either 3/4-inch or one-inch VTRs and a switcher interface is available for effects.

The new Ampex unit, the TRE-2, permits remote control of all editing functions incorporated in the VPR-2 and 2B VTR systems. The unit provides table-top control of two VPR machines for ease of editing, includes complete previews of all edit decisions, and allows trimming of scenes with the forward and reverse jog controls.

Datatron's new SmartScanTM option for its Vanguard editing system provides unparalleled access and control of the variable playback and record features incorporated in new one-inch helical VTRs. SmartScan software permits the operator to use the "broadcastable" variable speed functions as editing techniques so that a normal speed sequence can be slowed, frozen, or speeded up and executed automatically as a single event.

A learn mode permits the controller to memorize the exact tape speed and direction that the operator achieves using the variable speed control lever of the Vanguard panel. Once satisfied with the rehearsal, the operator marks in the edit point at which the effect is to start. SmartScan will then automatically preview the edit and execute it.

If a freeze frame is desired the frame to be frozen is marked. Then, just prior to the freeze, the play VTR is slowed and ultimately halted at exactly the frame desired. The duration of the freeze can be determined and the continuation of action resumed at normal or varied speeds. The direction is indicated on the data display at all times and off-speed rates are shown as a percentage of normal speed.

Convergence Corporation centered its exhibit around its ECS-103C "Auto-Conforming" editing system, which it had introduced at last year's NAB. The biggest news from Convergence was that the video animation system it has shown at a number of exhibits during the course of the past year is now fully developed and has

been spun off into a new company, Animation Video, a division of Convergence Corporation.

The system consists of a color video camera mounted on a full-capability animation stand and a VTR controller interfaced with a user-supplied one-inch or 3/4-inch video recorder. Dubbed the Anivid System, it accomplished all techniques common to single-cell animation in far less time than a comparable film-based animation system.

ADDA Corp. introduced its new generation of ESP still stores, the C series. A number of operational features have been added through the use of microcomputer control. A new control panel includes a prompter panel that steps the operator through all machine functions by giving clear, English-language instructions.

One of the chief new functions of the ESP-C Series machines is Multi-Pix, which permits the display of multiple stills on the monitor screen at the same time. By pushing an "A" key, a nine-still matrix is produced. The "B" key generates a 20-still matrix. Each still is added to the display one at a time at an operator-selected rate. Multi-Pix is seen as a significant aid to editing since the operator can get a sense of the flow as one still comes on after the next and can explore "sequence options" while operating in Multi-Pix. MCI/Quantel offers a similar function through the BROWSE mode employed in its DLS-6000.

JVC showed a prototype 10-frame still store, the VM-10A. A JVC spokesman stated that the unit was shown purely for the purpose of obtaining "feedback" from potential users and to get an idea of the applications



Ikegami's EC-35 Electronic Cinematography camera was the object of attention from motion picture delegates

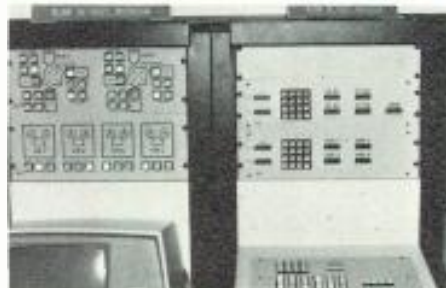

American Data's 3200 Machine Control System was one of several systems in this new genre



Americam from CEI was one of three new camera systems at SMPTE



Quantel's DLS-6000 Electronic still store featuring a "Browse" mode saw some conceptual competition from Adda's "Multi-Pix" feature

such a system might have.

Other innovations in recording technology included Ampex's showing of the first "true-frame playback helical videotape recorder." An option for the VPR-2B, the function doubles the vertical resolution of a freeze frame, greatly enhancing the quality of the picture when the VTR is used in this mode. Fernseh modified its BCN-51 to offer a BCN-51EP (Extended Play) model. This new model allows a full 140 minutes of recording time on a single reel. It is thought by Fernseh that this option will find application in film-to-tape transfer situations.

Vital Industries entered the digital video art realm in association with Digital Effects, Inc., of New York. The system, manufactured by Digital Effects, is called the Video Palette II and offers a magnetic pen and tablet operator interface for the generation of freehand artwork in the digital video domain. The system offers from 32 to 256 colors and a wide range of artist tools and techniques. The first such system is currently in use at J. Walter Thompson in New York, where a second such system is due to go on-line shortly. The cost of the system is approximately \$150,000.

A new company, Amtel of Doylestown, Penn. and Huntsville, Ala., introduced a line of SMPTE time code products that has already gained market acceptance during its infancy. Included in the Amtel line are the Model 3800 Edit Code Master, a reader/generator featuring user bit and color frame identification recognition; the Model 3700, due out later this month, which will generate the color frame ID number in addition to time code; and the Model

IMMEDIATE DELIVERY!



JH 110-B RECORDERS

Buy your new MCI Tape Recorder from Audiotechniques and you'll always get the fastest delivery, installation by our factory trained technicians, and warranty service with a smile. That's only a few of the reasons why we're MCI's largest dealer.

CALL AUDIOTECHNIQUES
800-243-2598

SEE MCI ADS PAGES 51-54

audiotechniques

652 Glenbrook Road, Stamford, CT 06902 Tel: (203) 359-2312
1619 Broadway, New York, NY 10019 Tel: (212) 586-5989

Circle 160 on Reader Service Card

NEWS FEATURE

3500 portable time code reader/generator. The Model 3700 (priced at \$6250), coupled with the 3800 Edit Master (priced at \$5695), will be one of the few systems available offering a foolproof way to ascertain color frame information automatically.

Another new line of SMPTE/EBU time code products was introduced to the American market by Avitel Electronics Ltd. of Beckenham, Kent (U.K.). In addition to its time code products, Avitel will market a variety of video adjuncts including amplifiers, cable equalizers, PDAs, power supplies, and routing systems. These products, which have proven performance in the overseas market, should be worthy of attention from U.S. broadcasters.

Fernseh and Ikegami introduced new angles in the telecine line. Ikegami showed a new TKC-970 color telecine camera and Fernseh showed its CCD-based FDL-60 operating with a new frame-by-frame color corrector. The color corrector, from Corporate Communications Consultants, Inc., is dubbed "The System," and as such has been shown as a standalone (see *BM/E's* NAB Show-In-Print, June, 1980). The new model, however, has been specifically adapted for use with Fernseh's FDL-60. Two versions are available, The System 60 and The System 60XL. Both units provide highly accurate, scene-by-scene color correction under imaginative computer control, but the 60XL is more fully articulated for the most demanding film-to-tape transfers. All FDL-60s in North America will henceforth include as standard the interface panel for use with the color corrector. The basic color corrector will sell for \$47,000 and the 60XL for \$100,000. By NAB time, a Pan-Scan option for transfer of Panavision films will be added.

Ikegami's TKC-970 employs three vidicon or Saticon pickup tubes and offers high quality pictures rated at 700 lines at center and 600 lines at the corners. The full range of automatic features expected in a high-end telecine are present.

In addition to the new products already mentioned, there were also advances in character generators, test and measurement equipment, lighting, power supplies, and ancillary systems. These new product introductions will be the subject of upcoming *BM/E* equipment surveys. A major new trend at SMPTE was a series of machine control systems from Fernseh, Control Video, American Data and others. These systems and their applications will be featured next month. **BM/E**

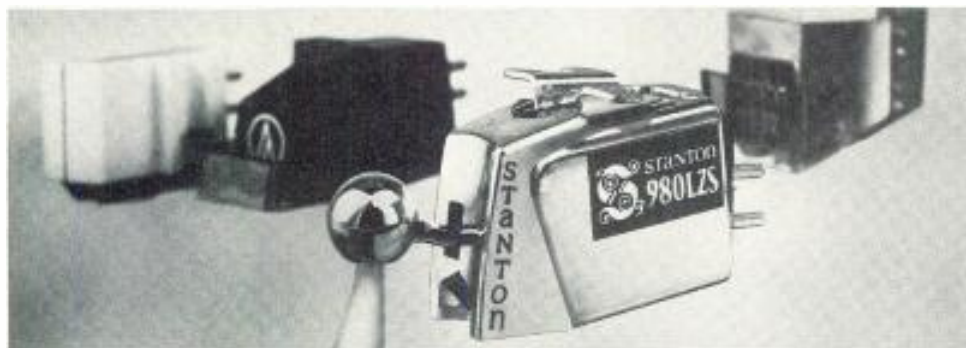

The moving coil replacement from Stanton Magnetics... the revolutionary 980LZS!

Now, a low impedance pickup that offers all the advantages of a moving magnet cartridge without the disadvantages of a moving coil pickup. It offers a dramatic new crispness in sound, a new crispness resulting from its rise time of less than 10 micro seconds. Low dynamic tip mass (0.2 mg.) with extremely high compliance assures maximum smooth trackability. The 980LZS connects to either a moving coil input or a separate preamp.

For moving coil advocates the 980LZS offers a new standard of consistency heretofore unattainable. For moving magnet audiophiles it provides one more level of sound experience without sacrificing the great reliability and sound characteristics of the best moving magnet assemblies.

For further information write to Stanton Magnetics Inc., Terminal Drive, Plainview, N.Y. 11803

 **STANTON**

Circle 161 on Reader Service Card

IF YOU'RE LOOKING FOR A FRAMESTORE TBC/SYNCHRONIZER, THE LAST THING YOU SHOULD LOOK AT IS THE PRICE.

You should start by looking at what it can do. And no TBC today can do more than the Phaser II by Digital Video Systems.

It's got it all: intelligent framestore TBC/Synchronizer. Multiple microprocessor control. Digital velocity compensator. Clean hot-switch between non-synchronous Heterodyne or direct color signals.

It freezes last pictures before signal interruption. Offers a Digital RS-170A Proc Amp. A 3 line adaptive comb filter. A 5 TV line hysteresis. An adjacent line dropout compensator. Full bandwidth freeze frame and freeze field. And an internal digital calibration generator.

Phaser II. Without a doubt, this is the state of the art in TBCs.

WE SAVED THE BEST FOR LAST.

Now that you know you can't get a more advanced TBC—look at the price. Only \$22,000. Our competition can't beat that either.



Digital Video Systems Inc.

Head Office: 716 Gordon Baker Rd., Willowdale, Toronto, Canada M2H 3B4 • Telephone (416) 499-4826

Electro-Voice's Greg Silsby talks about the Sentry 100 studio monitor



Production Studio, WRRR-FM, South Bend, Indiana

In all the years I spent in broadcast and related studio production work, my greatest frustration was the fact that no manufacturer of loudspeaker systems seemed to know or care enough about the real needs of broadcasters to design a sensible monitor speaker system that was also sensibly priced.

Moving to the other side of the console presented a unique opportunity to change that and E-V was more than willing to listen. When I first described to Electro-Voice engineers what I knew the Sentry 100 had to be, I felt like the proverbial "kid in a candy store." I told them that size was critical. Because working space in the broadcast environment is often limited, the Sentry 100 had to fit in a standard 19" rack, and it had to fit *from the front, not the back*. However, the mounting hardware had to be a separate item so that broadcasters who don't want to rack mount it won't have to pay for the mounting.

The Sentry 100 also had to be very efficient as well as very accurate. It had to be designed so it could be driven to sound pressure levels a rock 'n roll D.J. could be happy with by the low output available from a console's internal monitor amplifier.

In the next breath I told them the Sentry 100 had to have a tweeter that wouldn't go up in smoke the first time someone accidentally shifted into fast forward with the tape heads engaged and the monitor amp on. This meant high-frequency power handling capability on the order of five

times that of conventional high frequency drivers.

Not only did it have to have a 3-dB-down point of 45 Hz, but the Sentry 100's response had to extend to 18,000 Hz with no more than a 3-dB variation.

And, since it's just not practical in the real world for the engineer to be directly on-axis of the tweeter, the Sentry 100 must have a uniform polar response. The engineer has to be able to hear exactly the same sound 30° off-axis as he does directly in front of the system.

Since I still had the floor, I decided to go all out and cover the nuisance items and other minor requirements that, when added together, amounted to a major improvement in functional monitor design. I wanted the Sentry 100 equipped with a high-frequency control that offered boost as well as cut, and it had to be mounted on the front of the loudspeaker where it not only could be seen but was accessible with the grille on or off.

I also didn't feel broadcasters should have to pay for form at the expense of function, so the walnut hi-fi cabinet was out. The Sentry 100 had to be attractive, but another furniture-styled cabinet with a fancy polyester or die-cut foam grille wasn't the answer to the broadcast industry's real needs.

And for a close I told E-V's engineers that a studio had to be able to purchase the Sentry 100 for essentially the same money as the current best-selling monitor system.

That was well over a year ago. Since that time I've spent many months listening critically to a parade of darn good prototypes, shaking my head and watching

some of the world's best speaker engineers disappear back into the lab to tweak and tune. And, I spent a lot of time on airplanes heading for places like Los Angeles, Grand Rapids, Charlotte and New York City with black boxes under my arm testing our designs on the ears of broadcast engineers.

The year was both frustrating yet enjoyable, not just for me but for Ray Newman and the other E-V engineers who were working on this project. At this year's NAB show it all turned out to be worth it. The Sentry 100's official rollout was universally accepted, and the pair of Sentry 100's at the Electro-Voice booth was complemented by another 20 Sentry 100's used by other manufacturers exhibiting their own products at the show.

What it all boiled down to when I first started the project was that I knew that the Sentry 100's most important characteristic had to be *sonic integrity*. I knew that if I wasn't happy, you wouldn't be happy. I'm happy.

Market Development Manager,
Professional Markets



EV **Electro-Voice**
a **gulton** company

600 Cecil Street, Buchanan, Michigan 49107

In Canada:

Electro-Voice, Div. of Gulton Industries (Canada) Ltd.,
345 Herbert St., Gananoque, Ontario K7G 2V1.

Circle 163 on Reader Service Card

AES Convention: Panorama Of The Audio Future

ONCE AGAIN, an Audio Engineering Society meeting has brought onto one stage many elements of the intense audio development activity underway around the world. The AES 67th Technical Meeting and Professional Exhibits, running at the Waldorf-Astoria Hotel in New York, October 31 through November 3, 1980, attracted more than 6000 registrants (not counting exhibitor personnel) who filled most technical sessions and workshops and kept the exhibit floor busy most of the time. The more than 180 exhibitors, a record number, brought a veritable spate of new devices and systems.

For broadcasters, the main events were those concerned with digital audio, digital reverberation, audio processing, consoles, and advanced test equipment. Also looking useful to many broadcasters were some new tape machines, new amplifiers, a new microphone design, a handy new acoustic absorption material, and some others to be mentioned.

The workshop program, greatly expanded compared with those at earlier shows, was an outstanding success, with heavy attendance throughout. These "workshops" were exactly that, hands-on sessions devoted to instruction and practice in operating techniques. Some of the nine topics were: digital editing; sound reinforcement; high-speed duplication; audio for video; microphone techniques. The last drew a standing-room-only crowd, with many turned away at the door. This high interest springs from a widespread realization that, with digital recording reducing system distortion to vanishing levels, the technical quality of recorded material will depend in the future mainly on microphone techniques. (See article in *BM/E*, October, 1979, on this topic.)

Digital audio on the exhibit floor included devices and demonstrations from five firms associated for some time with this, the most revolutionary development of the early 80s, plus one newcomer. Soundstream, the first firm with a practical machine (see *BM/E*, February, 1977), was playing recent recordings made with the system: the quality has to be called magnificent. Soundstream so far has not sold the system, but has leased it to others; a spokesman for the firm told *BM/E* that they want to start selling in the near future.

Mitsubishi also had a truly splendid demonstration going, with recordings



At AES Convention, Neve demonstrated use of automated console in editing audio for video productions; note monitor screen at left



Visitors to Tektronix booth got intensive demo of production models of automated audio test system, AA501/SG505



Otari had new two-track and four-track "mastering" tape machines, described for *BM/E* by Steve Kranz, above

made and played back on its two-channel/four-channel digital machine, now in use commercially. Also on display was Mitsubishi's 32-track machine for commercial mastering, due on the market in a few months.

Sony emphasized its PCM-1600 converter for putting digital audio onto videotape machines, which has been used in recent months for a large number of commercial recordings. Sony's demo of recordings made with the system was a third masterly proof of the power of digital recording. All the digital demos drew crowds; Sony's was especially popular. Sony introduced a new electronic editor for the system, the DAE-1100, which in a demo clearly made the job precise and easy.

3M, with about 30 of its large digital mastering systems now in regular use in this country and abroad, put strong emphasis on the new version of the electronic editor for the system, which the firm claims is much easier to use than the first version (the editor is now in regular use in many studios). The 3M system also has been used for many commercial recordings, and demonstration material was spectacularly good in all the ways we have come to expect of digital recording.

JVC had converters quite similar in

action to the PCM series of Sony: they put PCM audio onto videotape machines. With them was a complete editor for the system. *BM/E* accepted an invitation to "run" the editor and found it extremely versatile and precise, with far more sophistication than a neophyte to the system could possibly absorb or even understand.

JVC also demonstrated its "AHD" digital audio disc, which records three should channels and a still-picture channel on a 10-inch disc with a capacitance pickup system. This is one of a number of audio digital disc systems developed in Japan that are the subject of intense discussion in that industry looking toward an agreement on a standard format. The Japanese believe (and we can agree) that the digital disc has a huge potential market, once compatibility among the various brands is established. It is a comparatively inexpensive device that will bring into the home the full glory of digital recording and reproduction.

Pioneer also showed a digital disc, the first indication that this firm was getting ready to jump in. Pioneer's prototype disc closely resembled the Philips Compact Disc, premiered in New York about a year ago. Six inches in diameter, it is recorded and played by

For superior in-cassette duplication, load up with Maxell



Maxell DUPLICATOR SERIES™ and COMMUNICATOR SERIES™ recording tapes are made for high-speed duplication with high-fidelity reproduction. Without fail.

That's because Maxell quality and technology are built into every audio product we make — from the mirror finish of our *exclusive* Gamma Hematite oxide tape to our rugged cassettes with their *unique* 4-function leader.

Maxell cassettes are magnetically and mechanically superior. They reproduce sound with exceptional accuracy, even after repeated playback. And, they smoothly transport the tape from one hub to the other without jamming, slipping or breaking.

The DUPLICATOR SERIES includes 30, 45, 60, 90 and 120 minute cassettes, and is unlabeled for your special needs. The COMMUNICATOR SERIES cassettes are individually boxed and are available in the same lengths, in addition to 7 and 10½ inch reels.

Maxell Corporation of America, 60 Oxford Drive, Moonachie, NJ 07074

maxell
PROFESSIONAL
INDUSTRIAL
PRODUCTS

Circle 164 on Reader Service Card

NEWS FEATURE

a laser beam, much in the manner of the optical videodisc.

Highly significant for the future of the audio digital disc was a technical paper authored by a large team of experts, half from Sony and half from the Philips organization in Holland, on format standards for such a disc. The authors testified to a joint effort by the two firms to arrive at the best possible standards. The two firms evidently accept the laser-played disc as the best. The combined power of Sony plus Philips can be expected to advance the push for standards.

The Analogic Corporation of Wakefield, Mass., showed the sweep of digital recording in another way: the firm is very busy making A-D and D-A converters for many of the digital tape machine sellers.

Digital reverb: a flood

Digital recording and reproduction of audio signals is just moving toward the front door for broadcasters; the machines are there, but they are still very expensive. Digital reverberation, though, which means special effects, too, is "in" on a grand scale. Hundreds of stations are using it, and it seems likely that hundreds more will buy digital reverb some time soon. This popularity springs from the great number of effects (reverb is just one) packed into the one box of a digital delay-line system (see articles in the July, 1980 issue). The reverb, too, is flexible and versatile, coming in dozens of varieties at the twist of a few knobs.

The exhibit floor reflected industry response to this market power. About a dozen firms, several of them new to the field or to the American market, showed digital reverb systems. Most of the firms established in the field brought new units.

New with digital reverb systems (or new to the AES) were Advanced Music Systems (U.K.), Publison Audio (France), Quad Eight, and Sony. Firms with new or improved units were EMT (Gotham Audio), with Model 251, the most elaborate system on the floor; Marshall Electronics, makers of the tremendously popular "Time Modulator," with a new one, the "Mini-Modulator," having new functions; Ursa Major, makers of the very successful "Space Station," with a new model at a somewhat lower price; Lexicon, with a lower-cost model to add to its line. MicMix brought a new digital/analog system, Model 500, which "synthesizes" the typical sound of a hall, church, or recording studio.

Eventide Clockworks, makers of the "Harmonizer," probably the most



Large "dual" automated consoles by MCI were main features of the Florida firm's exhibit; new tape machines were also present

used of all digital reverb systems, emphasized its new systems for turning small computers into spectrum analyzers. (see "Testing," below). DeltaLab Research introduced an add-on unit, the Memory Module, which supplies an additional two seconds of delay on its reverb systems.

The competition is encouraging the makers to put more and more functions and adjustments into their systems. No two of them do exactly the same things, so the broadcaster who wants a digital reverb system has an initially confusing set of choices. Hands-on trial, and plenty of listening, are essential.

Plates and springs: still here

Digital reverb is flying, but plate reverb is far from dead. At least four firms brought plate systems to the show, and all testified to active markets.

AKG had its long-standard plate systems, used by many recording studios for years. Audicon of Nashville had two models in a fairly new series it says is selling well to recording studios; prices are from \$2000 to about \$5000.

DB Cassette, a Swedish company, showed plates with specs that made them attractive for high-quality work. Studio Technologies of Lincolnwood, Ill., had Ecoplate II, a scaled-down version of its earlier Ecoplate I. Evidently a number of recording-studio directors like the "sound" of certain plates. Moreover, their prices are generally lower than those of digital reverb systems. But the plates, of course, lack the nearly endless versatility of the electronic systems.

A further step back in reverb cost was provided at the exhibit by firms showing spring reverb systems. The Mike Shop of Elmont, N.Y., brought a system imported from England, the "Great British Spring," priced around \$500 to \$600. Orban Associates had its long-available Model 111B. The Sound Workshop introduced two new models, the 242C and the 262, to add to the 242. Furman Sound had an upgraded version of the RV-1 using three springs. Protech Audio, a new company that has taken over and redesigned many products of the old Fairchild Sound Recording line, brought an improved Reverberatron. The low cost of the spring reverb, and the recent design advances

that have lifted flexibility and fidelity to respectable levels, have kept the spring-reverb market alive.

Processing: enhancement, control

With its strong recording-studio orientation, the AES show did not have the complete account of broadcast-style audio processors found at exhibits for broadcasters. Orban had the latest Optimod FM, Model 8100A, on demo. Audio and Design Recording of the U.K. and Bremerton, Wash., introduced a new processor, the Gemini "Easy Rider," which looks like a strong addition to the class of low-distortion, high-performing processors.

MXR of Rochester, N.Y., introduced a new dual limiter for use in any



At Audio Processing Systems booth, details of controls on new console got "hands on" explanation



Visitors at Eventide Clockworks' booth wore headphones to hear demos of special effects systems

MATER ARTIUM NECESSITAS*



If you're having as much trouble with our *headline as you're having with the heads on your RCA or Ampex 2" video machines, we've got the solution. Our Premium Quality Sakalloy® audio posts last 3 to 4 times longer than standard heads. We've become the world's leading manufacturer of premium audio heads by providing remarkable solutions to demanding industry needs. After all, *Necessity is the mother of invention. Call us today!

SAKI MAGNETICS, INC. A California Corporation. 5770 Uplander Way, Culver City, California 90230. (213) 649-5983 TWX 910-328-6100. Fox Hills Industrial Center.

Circle 165 on Reader Service Card

NEWS FEATURE

compression/limiting system, with controls for adapting it to the application.

The growing field of enhancement saw Apex, with an elaborate demo of its "Aural Exciter," including the new Model 602B, introduced at the recent NRBA Convention and designed especially for broadcasting. Orange County Electronics showed its low-cost version of the Apex system, the Nova enhancer.

The EXR Corp. of Ann Arbor, Mich., brought an enhancement system of an entirely different kind. The EXIII aims to improve apparent loudness and sharpen "presence" by adding back into the signal components that cancel various forms of degradation arising in typical audio recording and handling. This is based on complex psychoacoustic theory; the demonstration produced a loudness gain that the maker says is not from a power increase, which suggests that broadcasters ought to investigate this system.

Another form of processing useful in broadcasting was represented in the Lexicon "Time Compressor," which shortens or lengthens the duration of recorded material without a disturbing pitch change. A number of firms showed equalizers, of all shapes and sizes. For years the supply of equalizers has been up to meeting any broadcast need, in on-air or production work.

A firm with products over such a wide range that it needs one-spot coverage was the new Professional Audio Division of Panasonic. Included in the PAD showing were a series of turntables, including the Technics SP models that have been so important to broadcasters, and a number of others related to them. Also on the list were the fine tape machines sold under the Technics name; a new series of small and medium mixers; amplifiers and preamplifiers; a large series of loudspeakers; and a direct-drive motor designed for installation in the leading brands of disc-cutting lathes.

Consoles, full house

The show did not break with tradition: plenty of consoles were on hand. There was a strong showing of the super-large models for the most elaborate recording studio demands by firms long prominent in this area: Harrison, MCI, Neve, plus a newcomer from England with large automated console systems, Melquist Industries. Portable consoles with top-grade performance, suitable for remote work, came from Interface Electronics and Dallas Music Systems. Neve ran an excellent demonstration of the use of its Necam automation system in editing and mixing audio

NEW FM AND TV FIELD STRENGTH METER FIM-71

- Accurate — Direct Reading — Volts or dB ■ 45 MHz to 225 MHz — Continuous Tuning ■ Peak or Averaging Detector (switch selectable) ■ Wide or Narrow IF Bandwidth (switch selectable) ■ 20 dB or 60 dB Meter Range (switch selectable) ■ AM or FM Demodulator (switch selectable) ■ Calibrated Dipole Antenna, Mounted on Case for Near-Ground Measurements or Removable for TASO Measurements ■ 140 dB Measurement Range (1 μ V to 10 V) ■ 4½-Inch, Mirrored Scale, Taut-Band Meter
- Front Panel Speaker
- Recorder Output
- Rugged, Portable Package ■ Calibrated Signal Generator, 45 MHz to 225 MHz
- Battery or External Power ■ Use as Signal Source/Selective Voltmeter for Insertion Loss Measurements of Filters, etc. ■ Measures FM Harmonics to -80 dB



CONTACT US FOR DETAILS.

POTOMAC INSTRUMENTS

932 PHILADELPHIA AVE.
SILVER SPRING, MD. 20910
(301) 589-2662

Circle 166 on Reader Service Card



Exhibit floor, in ballroom of Waldorf Hotel, was crowded during most of the show with visitors showing intense interest

for video. Some other exhibitors with consoles were Audiotronics (the 700 series, new at NRBA), Audio Processing Systems, Cadac, Sound Workshop, Tangent, Trident, Allen & Heath, Audioarts, Solid State Logic, Soundcraft, Sphere, and Tapco.

Tape machines, another full house

Reel-to-reel tape machines matched consoles in plenty. Otari introduced the MTR-10 two-track and four-track "mastering" recorders. Stephens had a 24-track battery portable; it runs four hours on the rechargeable battery, travels in two cases weighing about 60 pounds each, and has claimed specs fully up to top recording-studio levels. Studer-Revox brought the new PR99, a two-channel half-track recorder aimed at broadcast use, in a performance class (and with a price) at the next level above the long-popular Revox B67. Nagra had a new portable with built-in interface to SMPTE coding, allowing ready syncing to video, film, or other audio machines. ITAM of London introduced the new Model 1600, using one-inch tape for 16 tracks.

Microphones: the new emphasis

As already set forth above, interest in microphone techniques is sharpening throughout recording and broadcasting. The microphones themselves are becoming more plentiful at all levels of performance. Audio-Technica added several new models to its line of electret condenser mics. AKG brought a new electret condenser series. Beyer had a new subminiature electret, the MCE-5, easily made invisible in lavalier form. Shure brought two new workhorse dynamics, the SM-77 and SM-78, aimed to supply ruggedness and excellent performance.

A very new kind of microphone, the "pressure zone" type, got extensive treatment in two technical papers and in the Crown International booth. Crown has developed a full line of the "PZ" mics and had a clever demonstration of their special qualities. The design has a flat plate across the front, leaving only a narrow slot around the edge through which acoustic energy can reach the diaphragm. If the mic is put up flat

against a broad reflecting surface, it benefits from the fact that waves reflected from the surface are in phase with incoming waves for a short distance, the "pressure zone," extending a fraction of an inch above the surface.

Since the mic receives energy only from the pressure zone, all direct and reflected energy arrives in phase; there are no differences in treatment of the

it Quality at \$1040.

THE PD II RECORDER plays mono tapes in "A" size cartridges. Stops automatically on 1kHz cue. Big and small buy it for the same reason: nothing else does this task so well, so long, so reliably, with so little maintenance. Also available in Reproducer Only for \$760.

**CALL TOLL-FREE
800-447-0414**

Ask about our no-risk, 30-day trial order. Call collect from Illinois, Alaska, Hawaii: (309) 828-1381. Standard 2-year warranty.

INTERNATIONAL TAPETRONICS CORPORATION
2425 South Main Street, Bloomington, Illinois 61701

Marketed exclusively in Canada by McCurdy Radio Industries, Ltd., Toronto



Circle 167 on Reader Service Card

Small Market Radio Weather

The SPERRY WEATHER RADAR SYSTEM for radio stations to forecast weather specifically for their locality.

A remarkable asset for reliability in weather analysis and a superb marketing tool for the station. The system includes installation and training of operating personnel.



**Unconditionally Guaranteed.
Financing Available.**

davidgreen

P.O. Box 590, Leesburg, Virginia 22075, Ph: 703-777-8660

broadcast consultants corporation

Circle 168 on Reader Service Card

CINE 60 POWERBELTS

NewsHawk



Millions of hours of TV news and documentaries, shot by thousands of news teams, worldwide. That's the proven performance record of Cine 60 Powerbelts... the veteran "NewsHawk" in the tough, hard-nosed business of newsgathering. What's more, you benefit from the unmatched experience of 18 years in portable power that only Cine 60 provides. So, tell us the make and model of your equipment. We'll send you complete data and information to cover your specific system. Cine 60—the "NewsHawk" Powerbelt and Powerpak Battery Systems. 160 models, 4 to 14 Amp-hours.

CINE 60
INCORPORATED

630 Ninth Ave. 8430 Sunset Blvd
New York, N.Y. 10036 Hollywood, Ca. 90028
(212) 506-8782 (213) 461-3046
Cable Address CINEBELTS
Telex No. 645647-01 TWX No. 710-561 6073

Circle 169 on Reader Service Card

NEWS FEATURE

sound, no matter what direction it comes from. Developers of the system claim it performs perfectly in many situations in which older mics fail, for example in cases of radical change in frequency response for moving sources. It is also easy to install since it goes up flat against any convenient surface.

Wireless mics and intercoms

Intercoms and wireless mics have been advancing sharply in recent years in efficiency and versatility. The two join in a kind of marriage in HM Electronics' new full-duplex wireless intercom system. Using miniature transceivers operating on 49 MHz and 70 MHz, the system allows a base station and up to four remote transceivers to talk with each other freely while listening "party line" style.

The S/N ratio is given as 90 dB; the units run on 9 V alkaline batteries and the maker says the system is free of interference from CB signals or other sources. The base station can be fixed or portable and the system can connect with many hard-wired intercoms, among them Clearcom, RTS, Telex, RCA, and others. *BM/E* walked away from the HM Electronics suite with one of the transceivers and stayed in easy communication with personnel even after going through long corridors up to 100 feet away. HM Electronics was also showing the extensive line of wireless mics introduced earlier.

Cetec Vega also showed a wireless intercom system, which allows a number of different configurations: one-way single-channel, one-way multiple-channel, two-way simplex or duplex (the latter with two persons). Operation is in the VHF band.

Swintek, an important source of wireless mics for a number of years, brought out a transmitter-receiver set, Mark 50A, with miniature units operating at frequencies from 150 MHz to 350 MHz. Both units are small enough for easy concealment in clothing. The transmitter weighs five ounces, puts out about 50 mW, accepts a variety of microphones (including the new high-level PZM), runs on a 9 V battery, and uses frequency modulation with 10 kHz deviation.

Telex introduced a new wired intercom system, "Audiocom," which allows a large variety of configurations. Included are portable headset and speaker stations (available with belt clip), fixed stations, and a switchboard. Up to 30 remote stations can operate on a single line. Plug-in cables and headsets with matching cords make the system easy to install.

More Pros Are Pro BGW

The BGW product line meets and exceeds the most demanding and varied needs of the professional. From the recording studio, to the touring system, from disco, to broadcast, pros Depend on BGW.

BGW offers the pro more choices in dependable amplifiers ranging from the 25 watt* per channel Model 50A, to the standard of the 80's, the BGW 750. There are also BGW amplifiers for the budget conscious ... the 100 watt* per channel Model 300 and the 175 watt* per channel Model 600 (both available with built-in 70/25 volt autotransformers).

BGW has extended its dedication in exacting design and construction to professional electronic crossovers with the Models 10 and 20. Both BGW crossovers feature exclusive Switchset™ to allow precision setting of crossover points without troublesome pots.

At BGW there are no shortcuts. Gimicks don't work. And we know hype won't stand-up under the stress and demands of professional applications. No matter what particular BGW product you choose—you can depend on it. And quite simply, that's why more pros Depend on BGW.

*Minimum average continuous power output drives 8-ohm loads over the full 20Hz-20kHz band.



Depend On Us.

BGW Systems
13130 South Yukon Avenue
Hawthorne, California 90250
(213) 973-8090
Telex: 66-4494

In Canada:
Omnimedia Corp.
9653 Cote de Liesse
Dorval, Quebec H9P 1A3
(514) 636-9971

NEWS FEATURE

Testing is more precise, easier

Audio testing has, of course, been undergoing a dual movement for a number of years: toward higher and higher precision; and toward more and more automation, making it easier, faster, more accurate, with operator hand adjustments and value judgements largely eliminated.

These fine trends were carried forward by several new systems in the

exhibit. Amber had its new portable distortion and noise meter, Model 3500, which measures in seconds down to the incredibly low levels (THD below 0.001 percent, for example) now reached by the best equipment. Tektronix had production models of the AA501/SG505 system, introduced in prototype at earlier shows, which applies fast automation to every variety of audio test at the new super-precision levels. Pushing one or two buttons gives immediate readings that would take hours of work with older equipment, and be far less accurate to boot.

Like most Tektronix equipment, the system is compatible with many units in the line, becoming, for example, a high-grade spectrum analyzer with the addition of a scope.

Hewlett-Packard had a somewhat similar system, the Model 8903A; it has microprocessor control, includes a very low distortion source, and automatically analyze a number of the basic audio parameters.

Marconi Instruments showed a full line of advanced test gear, some items carrying the AWA brand (for Amalgamated Wireless of Australia). Other

TOWER GUY WIRES RUSTING? RE-GALVANIZE WITH Z.R.C.[®]

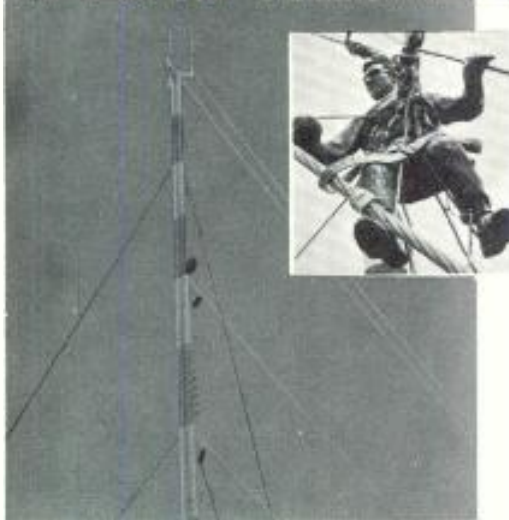

Get lasting
rust and
rust creepage
protection!

Liquid Z.R.C. is
easily applied
by mitt or brush

- Recognized under Component Program, Underwriters' Laboratories, Inc.
- Used to protect NASA antenna towers
- Passes Preece Test for hot dip
- Meets all pertinent Federal specifications
- Resists dry heat to 750°

READY FOR USE
FROM CONTAINER

Available in several
size containers



Z.R.C. — proven effective
for thirty years

ZRC CHEMICAL PRODUCTS CO.

21 Newport Ave., Quincy, Mass. 02171 Tel. 617/328-6700



Demo for Apex "sound enhancement" system invited visitor to operate controls while hearing results on headphones

spectrum analyzers were those of Con-silium Industri of Sweden, White Instruments, and Klark-Teknik of the U.K.

Eventide Clockworks made a strong entry into the analyzer competition with its imaginative systems for using small computers, hooked to Eventide digital converters, to form highly versatile test systems. Eventide units are available to interface with several of the most popular small computers.

Woelke Magnetbandtechnik, German instrument maker with products sold in this country by Audicon, Inc., of Nashville, showed an attractive line of wow and flutter meters of exceptional performance. A new item, the Wave Analyzer ME-302D, provides a clever method of running down the source of flutter. The frequency of the flutter is measured very accurately, and the instrument provides charting for relating this frequency to the diameter and angular velocity of the moving part causing the flutter. This will be enough in nearly all cases to identify the part.

Bruel and Kjaer, with some of the most elaborate spectrum analyzers on the market already in its line, moved into the field of time-delay spectrometry with the Model 5842 control unit. Added to a spectrum analyzer, this unit allows very accurate use of the

Circle 210 on Reader Service Card

Map shows number of 3M digital audio systems in use in various countries at time of AES show

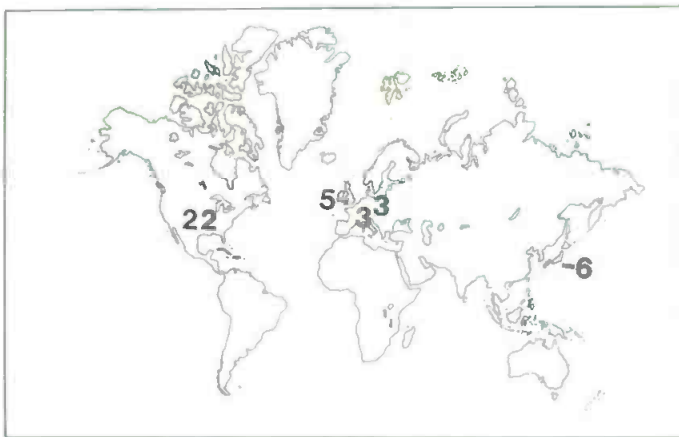

method of cutting the response at very short, selectable intervals after the direct sound. This allows separate analysis of the direct sound and of each important reverb signal.

Sound Technology was another firm with automated systems, including a distortion analyzer and a tape machine test system.

Amplifiers closer to perfection

An audio show without excitement about amplifiers would be almost a contradiction in terms. The trend of the last 10 years toward higher power and ever more miniscule distortion continued at the show. Sansui showed units with a new "feed forward" correction technique, with claims of infinitesimal distortion. BGW, Crest, Crown, SAE, and Yamaha were among those continuing their respective drives toward amplifier perfection. UREI entered amplifier manufacture for the first time with units at power levels up to about 600 W per channel.

Protech Audio has taken amplifiers of the Fairchild line and thoroughly renovated the designs. A new distribution amp, model DA1521, has 14 separate outputs, all with specifications at the state-of-the-art level. Protech reports especially strong response to the amplifier in television stations, where the audio needs elaborate routing with a minimum of degradation.

Miscellaneous: some good items

A product that looks important for radio stations renovating studios is Sonex, a foam acoustic absorption material with projections in rows like small copies of the "wedges" in the full-fledged anechoic chamber. The material comes in large sheets that can be tacked or glued up to walls or ceilings. The maker claims excellent performance, far better than acoustic tile, to 300 Hz, and good absorption as low as 100-150 Hz. Sonex is distributed by Alpha Audio of Richmond, Va. Their demonstration "walk-in" booth at the show reduced the ambient sound substantially.

Stanton Magnetics, already high on the broadcaster's list, brought a new

phono pickup, Model 980LZS, which the firm called the "moving coil replacement." The claim here is that the pickup, a moving magnet type, has the small dynamic mass and low distortion of good moving-coil types. The maker's spec of 10 μ s for rise time makes the claims persuasive.

The technical papers read at the convention added up to a comprehensive and important panorama of the audio future. A summary of the papers most interesting to broadcasters will appear in the next issue of this magazine.

BM/E



Professional Performance With A Bottomline Benefit.

The MX-5050B

The Otari MX-5050B. The 1/4" production machine that's earned the reputation of The New Workhorse. Because of quality that delivers unmatched reliability. Reliability that an engineer depends on. And accountability that makes your banker smile. Smiles, because it eases your production burdens while making a "return on investment." The 5050B offers the performance and features of machines which cost more than twice as much, and the "B" will keep on returning your investment long after it's written off.

Now, that's why we claim that dollars for dB's, it's the best you can own.

The New Workhorse

OTARI

Otari Corporation, 1559 Industrial Road
San Carlos, California 94070 (415) 592-8311 Telex: (910-376-4890)

Circle 172 on Reader Service Card

IF WE SAID YOU COULD MAINTAIN HIGH PRODUCTION STANDARDS FOR LESS THAN \$2000, YOU'D SAY WE'RE UNBALANCED.

By using a -10 unbalanced system, instead of +4 balanced, we eliminated hundreds of dollars of line amplifiers, transformers and balanced audio cables.

And that's how the Tascam 35-2B recorder/reproducer can save you money.

Without compromising your professional quality one nanoweber.

Unless you're running cable hundreds of feet long, there's no real difference between balanced and unbalanced. Since input/output levels and impedance aren't factors in recording quality.

So it pays to use the Tascam 35-2B in production, where you're

not running long cables.

Which brings us back to quality. We know the most important thing in broadcast production is the signal that goes on the tape. That's why the 35-2B meets NAB standards.

185 nanowebers per meter.

And with a switchable 1/4-track playback head built in, you get greater flexibility at no extra cost.

What's more, the 35-2B features a

rugged three-motor transport system and full IC logic transport controls.

Cue and Edit functions and a flip-up, hinged head cover help make editing easy and effortless.

For more details, see your Tascam Series dealer. He'll be happy to show you how being unbalanced can improve your balance sheet.

Balanced vs. Unbalanced

Specifications (15 IPS)

Wow and Flutter:

0.03% RMS (NAB weighted)
±0.05% peak
(DIN/IEC/ANSI weighted)

Frequency Response:

40 Hz-22 kHz, ± 3dB at 0 VU

Signal to Noise Ratio:

Reference 1 kHz at 10 dB above
0 VU (650 nW/m) 65 dB A
weighted (NAB) 92 dB A
weighted with integral dbx*

*dbx is a trademark of dbx Incorporated.



CS-600 Console optional.

The 32-2B and the compact 22-2 recorder/reproducers can save you even more money.

©1981 TEAC Corporation of America, 7733 Telegraph Road, Montebello, CA 90640.



Circle 211 on Reader Service Card

Testing Teletext: CBS Takes The Plunge

IT BEGINS this month — the first phase of CBS's major Los Angeles teletext experiment. Two L.A. TV stations — CBS's O&O KNXT and public KCET — are receiving and installing the equipment, a million dollars of Antiope gear supplied by Telediffusion de France. Personnel will be trained to operate the equipment, and in April the over-the-air service will begin.

Announcement of the experiment last fall followed closely CBS's petition to the FCC asking the Commission to choose a modified Antiope system as the U.S. teletext standard (see *BM/E's* October issue for details). That solo action stirred some controversy in the industry, with supporters of the two other leading contenders (Britain's Ceefax and Canada's Telidon) pointing out what they felt to be the shortcomings of Antiope and warning against hasty action. The Ceefax team was especially vocal about noting the high decoder costs associated with Antiope, while the Canadian Department of Communications (backing Telidon, of course) hinted that interactive videotex was given short shrift by CBS's proposed standards.

The flying fur has apparently left CBS undaunted, however, and plans for the test are moving right along. The main idea is to find out what kind of public reaction teletext will elicit — what kind of information viewers want from the "electronic magazine."

Initially, 100 decoder-equipped receivers will be placed in public areas for viewing. In-home testing will follow, and the number of sets may be increased, CBS says. CBS has been testing the Antiope system, along with the Ceefax and Oracle systems, since January, 1979, with on-air testing commencing in March of that year at its St. Louis O&O, KMOX-TV.

David Percelay will coordinate and implement the Los Angeles experiment in his position as director, CBS/Broadcast Group Teletext Project.

Double-barrelled approach

Working with commercial KNXT and public KCET is giving CBS the opportunity to take a double-barrelled approach in its teletext programming. The focus at KNXT will be on commercial applications of teletext, in addition to its informational and educational uses. The KNXT menu will probably

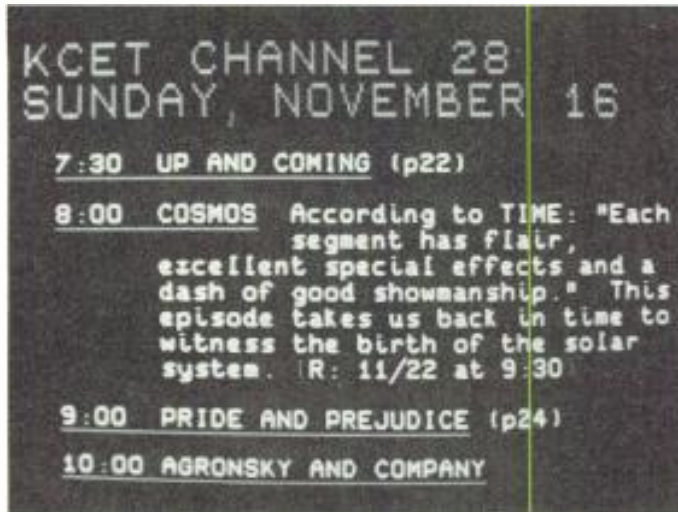

Detailed program listings will be offered by KCET as part of its teletext menu



The WGBH Caption Center is supplying KNXT with captioning for a number of prime-time network shows

offer such fare as local and national news, sports, weather, financial information, classified ads and tie-ins to national advertising, entertainment listings, and traffic conditions.

CBS is emphasizing the possibilities teletext offers for localized programming. Among the other uses CBS suggests are travel schedule information, which could be updated regularly via interface with airline or rail computer systems, and a shopper's guide offering the latest on sales, bargains, and specials.

Other local-oriented applications could include traffic conditions, emergency phone numbers, a calendar of events, and classified advertising.

A special feature of KNXT's teletext programming will be captioning for the hearing-impaired. Millions of hearing-impaired viewers are currently denied

full enjoyment of television and access to its information. The line 21 closed captioning system now being supported by ABC, NBC, PBS, and the National Captioning Institute has been categorized as too limited in application by CBS. A full teletext system, CBS asserts, would make possible not only captioning but also a wide variety of other services for hearing-impaired as well as hearing viewers. Additionally, teletext technology allows captioning at different speeds, in different colors and sizes, and at different places on the screen, CBS argues.

Joining CBS and KNXT in the captioning experiment is the Caption Center of WGBH, Boston. The public TV outlet has been captioning TV programs since 1971 and produces *The Captioned ABC News*, described as the only same-day national news broadcast

NEWS FEATURE

for the hearing-impaired. The Caption Center will be providing captioning for many of the CBS prime-time programs aired by KNXT during the experiment, and to aid operations an L. A. branch of the center will be opened.

KCET a teletext pioneer

Public station KCET, cooperating with CBS in the test, is no newcomer to teletext. KCET put itself in the forefront of this new technology over a year ago when it initiated testing of teletext using Antiope equipment. That test, conducted during November, 1979, did not involve the viewing public, but on March 19, 1980 the station's audience was asked to participate in an over-the-air teletext demonstration. Armed with a response form printed as an ad in local newspapers and distributed in high schools and colleges, over 5000 of the 100,000 viewers answered questions on how the teletext transmission affected their signals.

According to the station, the responses indicated that a still greater portion of the TV signal will be usable for teletext as more new receivers come into use. (The transmission currently occupies two lines.) Most of the 30-

minute March 19 program was devoted to demonstrations of teletext programming and descriptions of possible uses. About five minutes were devoted to the actual transmissions.

Given that background (KCET was not only the first public station to experiment with teletext, but also the first UHF), KCET seems like a natural choice for participation in the CBS test. Slated for inclusion in KCET's teletext magazines are such items as cultural events listings, a program guide, and various kinds of educational material. Some of the examples it used in its March demonstration illustrate well the possibilities: during a sports program, viewers could get statistics on an individual player; a biographical sketch on a singer was made available during an opera broadcast; viewers could call up statistics on their own communities during a news item on inflation.

The equipment loan from Antiope and a grant from the Arthur Vining Davis Foundations have been important to KCET in its teletext ventures, although Richard Gingras, in charge of the station's teletext program, indicated that more funding would be needed. Gingras said that money would be sought from foundations, corporations, and other federal and private funders.

Gingras, KCET's director of planning and corporate development, has

had his finger in the teletext pie since joining KCET in the spring of 1979. KCET's other teletext principal is Hartford N. Gunn, senior vice president and general manager. Gunn, who served as PBS's first president from 1970 to 1976, was instrumental in PBS's move to satellite program distribution.

WETA tries out Telidon

Another major teletext project is getting underway now on the East Coast. WETA-TV, the public station in Washington, D.C., is cooperating with the Alternate Media Center of New York University in an over-the-air test of the Telidon system. WETA's Don Quayle told *BM/E* that the Canadian equipment is expected to arrive in Washington around February 1 and should be installed and operable by March 1, when the broadcasts are scheduled to begin.

The station is already transmitting the four-line Telidon signal in its vertical interval and has been conducting signal strength measurements and error rate reproduction to determine the best locations for its receivers. Fifty receivers will be installed in the first phase of the project, 10 in public places (such as libraries, schools, and social clubs for the handicapped) and the remainder in private homes. Quayle said that the sta-

Winsted



MODEL 900A

EDITING CONSOLE

Holds all sizes of ENG/VTR equipment!

This totally modular console has every feature for editing efficiency—shelves that adjust on 1" increments, sliding pullouts for added working space and easy maintenance, total access to VTR's, editors, monitors and equipment. Rolls easily on large casters—even into a van to create a mobile unit! For full-line catalog of video consoles, tape and film trucks, film / videotape storage systems, call or write

THE WINSTED CORPORATION 8127 Pleasant Ave. So., Minneapolis, MN 55420
(612) 888-1957 Toll Free Number: 800 328-2962

Winsted

Circle 214 on Reader Service Card

"The Originators"

Cezar International, Ltd.
is almost three years young.
It seems like yesterday.

In that time we've introduced The Infielder, The Black Box, The Match Box, The Fine Box, The Audio Panel and the EA-3x with The "Executive" Command.

Hmmmm. Maybe it wasn't yesterday.*

*Note: We are working on tomorrow.

Check with your favorite distributor. Chances are... he's one of ours.



EA-3x

\$4,495.

Cezar International, LTD.

491 Macara Avenue, Sunnyvale, CA 94086 (408) 733-1436

Circle 212 on Reader Service Card

JOIN THE CSI NETWORK



Now you too can become a member of one of the fastest growing networks in radio broadcasting. CSI's more than 450 satisfied transmitter owners.

You can share the advantage of superb quality craftsmanship and dependable service others expect from CSI.

CSI . . . the network you'll be glad to be affiliated with.



3800 South Congress Avenue • Boynton Beach, Florida 33435 • Phone 305/737-5626 • Telex 513458

Circle 176 on Reader Service Card

NEWS FEATURE

tion had targeted three neighborhoods for receiver placement. Participation in those neighborhoods is being solicited via a questionnaire mailed to randomly selected addresses. The purpose of the selection process, Quayle explained, is to find the "average consumer," not viewers with special informational needs or interests.

All of the decoder-equipped sets will have an audio cassette attached to monitor usage. Offerings will include the basic complement of news, sports,

and other information, as well as educational information ancillary to WETA's programming. This will probably include local informational tie-ins to national programming — for example, references, reading lists, or social service information.

Quayle said that the decision to go with Telidon for the pilot project was based on two considerations. The station, he said, got the best economic proposal from the Canadians; equally important, however, was their conviction that Telidon is technically superior to the other systems, especially in its graphics reproduction.

In-home placement of decoder-equipped sets will follow placement in public areas around Los Angeles



SAME TIME, NEXT YEAR.

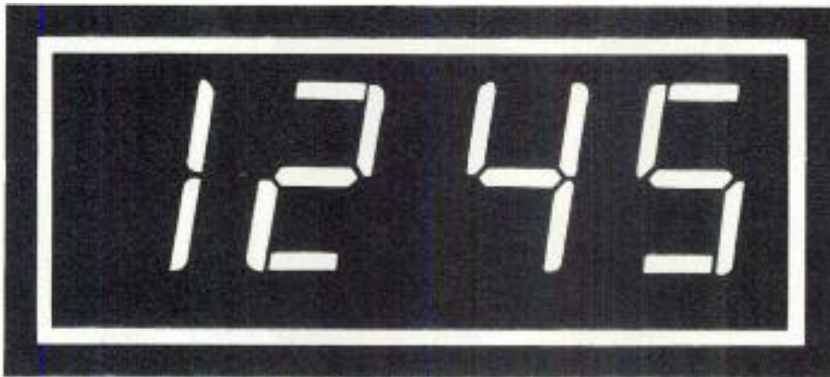

The news will occur every hour on the hour, the closed circuit feed at precisely 11:30:30, and you'll probably need to input the output from the satellite each week at 7 . . . same time, next year. It's too important a job to trust to mechanical timers of questionable accuracy or their human counterparts.

Enter Chrontrol:

Chrontrol's advanced microprocessor technology has improved the levels of time control accuracy to seconds and

is surprisingly inexpensive. When you assign Chrontrol the responsibility for switching, you've freed your time, relieved your mind and achieved a degree of unparalleled preciseness. Chrontrol, hard-wired rack mount or plug-in desk top model, ensures that all your incoming or outgoing information, all your feeds, all your closed circuit data will be broadcast and recorded over and over again as programmed . . . same time, next year.

CHRONTROL

Those interested in saving time, energy, and money should call or write Lindburg Enterprises, Inc., 4878 Ronson Ct., San Diego, CA 92111, (714) 292-9292, TLX/TWX 910-335-2057. Time was. Chrontrol is.

Circle 177 on Reader Service Card

Decoder price won't be much of a problem once all the systems go into mass production, Quayle predicted, saying that he expected the current price differences to more or less disappear. The first phase of WETA's teletext test is scheduled to last 18 months; if additional funding can be obtained the station plans to extend the project with an increased number of decoders.

What's in store?

Even if the exact direction teletext will take in the U.S. is not yet clear, it seems likely that the next few months will see at least a partial lifting of the clouds. The information on audience needs and acceptance of broadcast teletext gathered in both the CBS and WETA tests should give broadcasters plenty to think about.

Whether any one system will be settled upon soon, however, remains to be seen. Gene Mater, CBS/Broadcast Group vice president, told the news conference announcing the CBS project that "in the best of all possible worlds" the FCC could make up its mind on a teletext standard by 1982, but actual introduction of on-air teletext would have to wait until a standard was set.

So what's next? No one may know yet, exactly, but one thing is certain — U.S. broadcasters will be keeping an eye on the teletext tests. **BM/E**

System One™

- Reel to Reel
- Sequential Controller
- Random Selector
- Kartel
- Reel to Reel
- 19" Rack



Mini One Bay . . .

an economical automation system that provides short walk away time. BC's programmable 1600S Sequential Controller gives access to 16 events — expandable to 32 — from up to 9 repeatable audio sources. Programmable clock repeats station format in 15 and 30 minute or 1 hour segments. Audio monitor alarm. Complete stereo system \$9225. F.O.B. plant.

BROADCAST CONTROLS
bc 9155 Brookville Road
 Silver Spring, Maryland, 20910
 (301) 587-3505

Circle 178 on Reader Service Card

NEC DME® System features:

- Single or dual channel operation with DME dual system for simultaneous single-studio multi-channel or two-studio single channel use.
- Complete frame synchronization on all inputs including TBC, freeze and Velcomp capabilities.
- Intelligent digital control system with 18 complete memory locations of start and finish position/size and special effects.
- Automatic pan and tilt control with limit for not going out of frame.
- New vertical and horizontal inversion effects including "tumble" using new digital control.
- New "mosiac" effect with adjustable tile size for dramatic visualization of show openings and closings.
- TTL pulse circuitry for sequential and external triggering to permit extensive interface with editors and other creative controllers.

NEC DME Control features:

- Operation with DME or existing DVE® Digital Video Effects System for full digital control of all system functions.
- Memory capacity for 18 complete pattern manipulations including start position and size, finish position and size, posterization and

solarization effects, freeze frame or freeze field and real time frame entry of effect duration . . . all effects instantly and exactly repeatable.

- Automatic pan and tilt functions with selectable limit to prevent pattern transition beyond blanking.
- Memory reveal function to permit image-track effects by revealing the entire memory and removing normal mask.
- Bridging of all memories to permit multiple effect sequences up to 999 frames each for a total capacity of 17,982 frames of pre-programmed effects.
- Auto-freeze for pre-timed incremental freezing.
- All digital construction including digital shaft encoder instead of conventional faders.

NEC

NEC America, Inc.
Broadcast Equipment Division
130 Martin Lane
Elk Grove Village, IL 60007

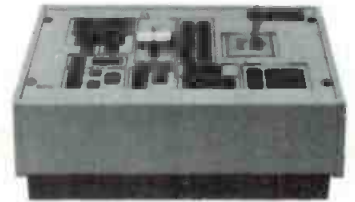

®Registered Trademark 1980

NEC INTRODUCES THE MOST FLEXIBLE DIGITAL EFFECTS SYSTEM AVAILABLE!

All digital control
All function memories
All DVE compatible



Circle 179 on Reader Service Card



**HAVE YOU MISSED
SOMETHING LATELY?
TRY SATELLITE ENG!
THE AFFORDABLE ALTERNATIVE TO
TRANSMIT YOUR NEXT HOT STORY HOME.**

Our transportable earth stations can put you on the air quickly from almost anywhere; the heliport atop Cobo Hall in Detroit, a parking garage next to Madison Square Garden or a football field in the North Carolina hills. You tell us where and we'll bring your story home.

ABC, CBS, NBC, ITNA, SIN, Gannett, Bonneville, RKO, NPR and many more have all used our satellite transmission services.

Completely self contained, our satellite earth stations are ready to roll for your next assignment.

For details and rates call
Mark Wallhauser, Wold Communications,
(703) 442-8550.

WOLD COMMUNICATIONS

*a division of
The Robert Wold Company*

NEW YORK
Empire State Building
New York, NY 10118
(212) 947-4475

LOS ANGELES
11661 San Vicente Blvd.
Los Angeles, CA 90049
(213) 820-2668

WASHINGTON, D.C.
8150 Leesburg Pike
Vienna, VA 22180
(703) 442-8550

New Rule Might Eliminate Need For Renewal Hearing

By Frederick W. Ford and Lee G. Lovett; Lovett Ford and Hennessey, P.C., Washington, D.C.

BROADCAST LICENSE RENEWAL hearings are serious proceedings which involve considerable amounts of time and money spent by FCC licensees. Also, such hearings can not only result in the loss of a station license but also can jeopardize the present and future status of a broadcaster as licensee of other stations as well.¹ What can a broadcast licensee do to avoid such a hearing if it becomes apparent that the Commission is investigating some aspect of station operations? Moreover, how can this be done without running afoul of the FCC's *ex parte* rules, which prohibit contacts with Commission personnel on the merits of pending proceedings?

Effective November 10, 1980,² the Commission has adopted a new rule³ that formalizes procedures for a response to staff investigations. This article will briefly examine the new procedure, as well as the continued applicability of the *ex parte* rules.

The investigation process

When facts which might require a hearing come to the attention of the Commission, it sends a staff investigator to speak with the licensee and/or the station manager, review relevant files, and even interview station employees, if that is necessary. The licensee or manager may comment and explain the evidence obtained by the investigator. Communications counsel may be present during this review of the evidence by management. After the investigation has been completed, the licensee can comment on any additional matters the staff may have discovered.

Once all the necessary evidence has been collected, the staff investigator prepares a report, which includes copies of all statements made by any witnesses. The report is then reviewed by the Complaint and Compliance Division of the Broadcast Bureau. If a hearing is recommended at this

level, the matter is passed up to the Hearing Division and the chief of the Broadcast Bureau to judge whether the facts warrant designation for hearing.

The existing rules allow the licensee and its counsel to comment in any form on these matters to the Commission or the staff until a hearing designation order is issued. Often in the past, licensees have submitted memoranda to explain their positions on the facts uncovered by the staff investigation. Whenever the staff has been requested to forward such memoranda to the Commission, it has usually done so. Apparently, in some cases, the licensee has delivered such memoranda directly to the Commissioners themselves once it has become apparent through a public notice that the staff investigation and recommendation will be considered at a particular meeting.

The new rule

The recent Commission decision does not change this procedure as much as the ruling formalizes it and brings such licensee comments in line with other rules and

¹The *KORK-TV* decision is a case in point. (*Western Communications, Inc.*, 59 FCC 2d 1441 [1976], *aff'd in part sub nom. Las Vegas Valley Broadcasting Co. v. FCC*, 589 F. 2d 594 [1978].) The proceeding lasted nearly eight years. The incumbent licensee of KORK-TV was disqualified for fraudulent billing practices and misrepresentation.

²*Memorandum, Opinion And Order*. In the Matter of Petition For Amendment of Part 1, Rules and Regulations, to Provide Opportunity for Licensee Response to Staff Investigatory Reports Prior to Designation for Hearing, RM-3227, 47 FR 65595, 48 RR 2d 439 (1980).

³The new rule is 47 CFR §1.88. The text of the new Rule 1.88 reads as follows:

"Predesignation pleading procedure. — In cases where an investigation is being conducted by the Commission in connection with the operation of a broadcast station or a pending application for renewal of a broadcast license, the licensee may file a written statement to the Commission setting forth its views regarding the matters under investigation; the staff, in its discretion, may in writing advise such licensee of the general nature of the investigation and advise the licensee of its opportunity to submit such a statement to the staff. Any filing by the licensee will be forwarded to the Commission in conjunction with any staff memorandum recommending that the Commission take action as a result of the investigation. Nothing in this rule shall supersede the application of our *ex parte* rules to situations described in §1.203 of these rules."

FCC Rules & Regulations

policies, particularly the *ex parte* rules. The new rule provides that the staff may, at its own discretion, notify a broadcaster of the general scope of an investigation. If the licensee wishes to respond, the broadcaster may submit a pleading to the staff. The pleading would be automatically forwarded to the Commission along with any staff memoranda recommending to the Commission a particular course of action.

The Commission decision came in response to a petition for rulemaking filed by a Washington, D. C., communications attorney and generally supportive statements filed by the National Association of Broadcasters, the Federal Communications Bar Association, and the Communications Center of the New York Law School. The petitioner also sought to make copies of witness statements, the actual investigatory report, and the staff's recommendation to the Commission available to the licensee *prior* to the designation for hearing, so that the licensee could use these materials in preparing a response. However, the Commission determined that these items should *not* be made available prior to hearing designation. In particular, the Commission felt that the cooperation of witnesses would be imperiled if confidentiality could not be guaranteed. Witness lists and statements are provided by the Commission as part of the discovery process once proceedings have begun. However, to do so earlier would hamper an investigation. As the Commission stated:

In many cases, witnesses cooperate and give testimony, even though they are concerned about the personal conse-

quences such as current job security and ability to obtain jobs with other employers. In those cases, they would not want their cooperation exposed if the case is not designated for hearing or if the Bureau does not plan to call them to testify.⁴

Ex parte consideration

The Commission noted that the new rules will not supercede in any way the requirements of the *ex parte* rules. Those rules⁵ specifically prohibit any oral or written communications with the Commissioners or the staff regarding the merits or outcome of a proceeding. The *ex parte* rules pertain to any "restricted" processing. In situations involving the new Commission procedures, the proceedings become "restricted" once a renewal application is designated for hearing or whenever a petition to deny is filed. In the case of a petition to deny, the proceeding remains "restricted," even if the petition is denied "until the order disposing of the petition is no longer subject to reconsideration by the Commission or to review by any court."⁶

Conclusion

The recent Commission ruling formalizes procedures by which licensees can avoid straying into the area of *ex parte* communications. If you become aware, or if the Commission formally notifies you, of any investigation, you are advised to contact your communications counsel. In conjunction with counsel, a pleading can be submitted which might obviate the need for a hearing. **BM/E**

⁴Memorandum, 48 RR 2d at 442.

⁵Part 1, Subpart H of the FCC's Rules, specifically §§1.1201-1203.

⁶47 CFR §1.1203 (b) (1).

THE CASE FOR SURVIVAL.

Here's a custom case specifically engineered to protect your valuable equipment.

EXCALIBUR cases are

- Rugged—the case that can take it.
- Dependable—the case you can always count on.
- Strong—the case for the long haul.

Choose from the finest materials and hardware available. Built to your specs, or you may consult with our designers regarding your particular needs.

Write or call today for your EXCALIBUR Survival Kit.



EXCALIBUR

INDUSTRIES

12251 Foothill Blvd., Lake View Terrace, CA 91342 • (213) 899-2547

TWX. 910-494-1233

Circle 181 on Reader Service Card

BM/E's 1981 Great Idea Contest Starts Now. Enter!

Mail to:

Editors, BM/E

295 Madison Avenue

New York, New York 10017

1981

Entry Form

Name _____ Title _____

Station Call Letters _____ City _____

State _____ Zip _____

Telephone No. _____

Licensee _____

Class of Station at which idea is used (check one)

TV _____ FM _____ AM _____

Category: Audio _____ RF _____ Video _____ Control _____

Objective or Problem: (In few words; use separate sheet for details)

Solution: (Use separate sheet—500 words max)

I assert that, to the best of my knowledge, the idea submitted is original with this station; and I hereby give BM/E permission to publish the material.

Signed _____ Date _____

INTRODUCING THE GUIDEBOOK TO VIDEO IN THE 80s.

BM/E's ENG/EFP/EPP HANDBOOK



Guide to Electronic News Gathering. Electronic Field Production & Electronic Post-Production for the 1980's.

With constant changes in technology and the proliferation of products, there are no quick and easy purchasing decisions in the ENG/EFP/EPP market. And with each buying decision impacting on plans for the future, you need all the help and advice you can get. Now.

So whether you're looking to expand your present system or to upgrade it, or are making a commitment to field production for the first time, *now's* the time to order your copy of **BM/E's ENG/EFP/EPP HANDBOOK: Guide to Electronic News Gathering, Electronic Field Production & Electronic Post Production for the 1980's.**

A PRIMER FOR NEWCOMERS. AN ADVANCED REPORT FOR PROFESSIONALS.

This guidebook is designed to be *the* authoritative text on the entire subject of electronic journalism, field production and post-production in the 80's. And it is skillfully written for both technical and non-technical readers—broadcast and non-broadcast users.

A DISTINGUISHED EDITORIAL TEAM

Written by C. Robert Paulson, principal author of BM/E's best selling 1976 *ENG/Field Production Handbook*, this brand new guidebook features an introduction by Joseph A. Flaherty, Vice-President, Engineering and Development, CBS Television Network. And it has been edited by the distinguished team of James A. Lippke, BM/E's Editorial Director, and Douglas I. Sheer, BM/E's Director of Special Projects.

Contents Include:

Part I/Overview: Chapter 1, An Aerial View of the 1980's; Chapter 2, Communication Becomes Electric; Chapter 3, Overview of Hardware Development Trends & Needs.
Part II/Electronic Field Production: Chapter 4, Cameras, Pickup Tubes, Lenses & Lighting; Chapter 5, Video Recorders; Chapter 6, Field System Accessories.
Part III/Electronic Post Production: Chapter 7, Editing Systems & Controllers; Chapter 8, Video Switchers; Chapter 9, Digital Video—TBC's; Chapter 10, Television Audio; Chapter 11, Post-Production System Accessories
Part IV/Wrap-Up: Chapter 12, Putting It All Together.
Appendices: (A) TV Standards; (B) Bibliography & Reference

Together they have compiled:

- Over 300 pages of detailed information
- Twelve fact-filled Chapters
- More than 300 illustrations, charts and photographs
- **ALL FOR THE SPECIAL LOW INTRODUCTORY PRICE OF \$15.95 (List Price: \$19.95)**

YOU'LL REFER TO THIS HANDBOOK AGAIN AND AGAIN.

Whether you're a broadcaster, an independent producer, an agency creative, a corporate video manager, a medical, educational or religious user, a programming executive or a government administrator, you'll want to make **BM/E's ENG/EFP/EPP HANDBOOK** an essential part of your buying process—as a planning guide for the 80's and a buying guide for today.

ORDER YOURS TODAY FOR ONLY \$15.95

Save \$4.00 off the regular list price of \$19.95 by sending in this coupon today.

BM/E

BM/E

295 Madison Ave., New York, N. Y. 10017

Please send (____copies) of BM/E's ENG/EFP/EPP HANDBOOK at the special introductory price of only \$15.95 per copy. (offer good through 2/28/81)

Name _____

Company _____

Address _____

City _____ State _____ Zip _____

Country _____

Total Amount \$ _____

N.Y.S Residents Add 8% Sales Tax \$ _____

Postage and Handling: \$2.85 U.S.;
\$4.00 Foreign \$ _____

Total Enclosed \$ _____

Charge it to my BankAmericard, VISA, MasterCard, or InterbankCard; # _____

Makes checks payable to Broadcast Management/Engineering.

LITTLE THINGS MEAN A LOT

Video Aids' Party Line Intercom Systems are now available with belt clips—a small but important added convenience requested by you. Little things like the compact size (PL-1's are only 3" x 2½" x 2") and the convenience of individual gain controls on each unit really count.

If you're tired of patching two or more camera intercom systems together and dissatisfied with the results, you should buy VAC's PL series party lines. The VAC system fills the needs of the audio and video engineers, technical director, camera personnel, floor director and lighting men for TV productions.

The Model PL-1 units (\$60) may be used without the master PLS-1 unit (\$100) if +8 to +12 volts is available. Only 10 to 15 mA of current per PL-1 is used for operation. Order PL-1BC (\$63) for units with the new belt clip. Interconnection requires 2 wires plus shield. An individual volume control on each unit affects only the listen level for the individual at each position. This is ideal in noisy environments, such as football stadiums, since the operator can adjust his own volume from a whisper level to a volume in excess of any normal listening requirement.

The master PLS-1 unit is in a cabinet which includes a dc power supply. Up to 10 headsets on the same line can be handled by the model PLS-1 when used with PL-1's at the remote headsets. Headsets used should be low impedance with carbon microphones.

Join the crowd and solve your party line problems with VAC's PL-1's. Little things can mean a lot.



VIDEO AIDS
of colorado

1930 Central Ave.
Boulder, Colorado 80301
phone (303) 443-4950

Circle 185 on Reader Service Card

Great Idea Contest

FIRST ENTRIES 1981 VOTE NOW!

1. FM Stereo Peak Limiter

David E. Doughty, Chief Engineer
WTLB-FM, Utica, N.Y.

Problem: To build a high-quality FM stereo peak limiter for use at a remote transmitter site connected to the studio via equalized phone lines.

Solution: This circuit provides a high-quality stereo signal for minimum cost. It should be especially interesting to stations using FM Dolby since no audio compression is used. (A change in the preemphasis and deemphasis circuits is required with FM Dolby, however.) The measured frequency response of our unit was within 0.5 dB from 20 to 20,000 Hz with deemphasis in, and the measured THD never exceeded 0.07 percent at any frequency at a level of +15 dBm. Residual noise was 85 dB below +15 dBm.

The input circuit is 600 ohms balanced, to be connected directly to the output of a telco line equalizer after disconnecting the line amp provided by the phone company. There is 75 μ s preemphasis after the input transformer and input level control. IC-1 provides enough gain to make up for phone line losses and is not bothered by RF problems.

The clipping diodes, back-to-back 1N914s, are operated as soft clippers, giving the limiter a uniquely transparent sound. The output waveform is similar to that of a high-quality vacuum tube amp being driven into saturation.

The output amp (IC-2, Q1, and Q2) has an output capability of +22 dBm. It also provides the appropriate deemphasis when necessary. The low source impedance of the output amp allows a transformerless output system and "poor man's" attenuators to be used, eliminating possible ringing from an output transformer.

IC-3, operated as a differential amp, measures the voltage drop across the 1K resistor driving the clipping diodes, amplifies it, and drives a VU meter to give an indication of relative clipping depth.

To set it up, feed a 400 Hz sine wave at -20 dBm to the input with the input level control fully open. Switch the

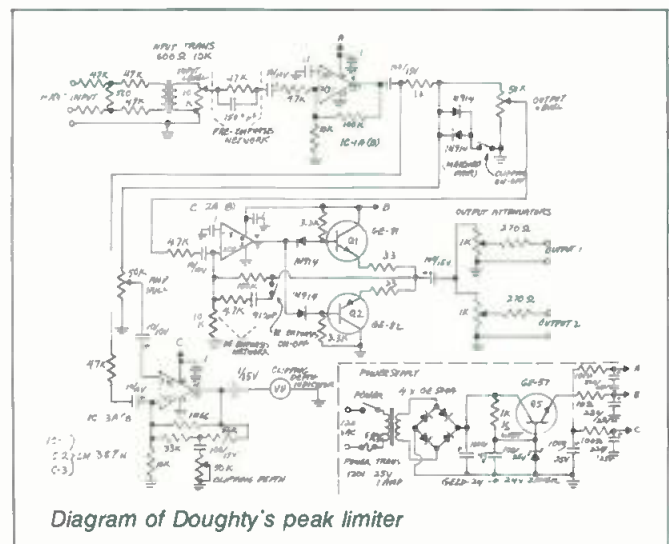

Diagram of Doughty's peak limiter

INTRODUCING PAGBELT. IT'LL COST A LITTLE MORE. BUT YOU'LL THANK US.



No matter what portable power source you've been using for video equipment, accessories or lighting, we're about to make you unhappy. Very unhappy. Because we have something better. And safer.

Meet Pagbelts. Quite simply, we believe, the best-engineered, most reliable, fast-charging Nicad powerbelts in the world. By far.

Sound shocking? Then start by considering safety and reliability: Pagbelts' exclusive safety lock that (unlike some other belts) makes it impossible for you to hurt yourself—or your equipment—by using them while charging. The individual thermal cut-out protection provided on every pair of cells. The flexible, unbreakable wire "loom" network used instead of conventional wiring. The special cells, designed exclusively for video systems' higher power drain. And the sturdy leather belt that houses them.

But that's only the beginning. Because Pag's intelligently-designed belt systems feature chargers with a "brain" that considers temperature, pressure and voltage conditions, to precisely deliver full charge, and by connecting to

virtually any AC line in the world without special equipment.

Besides being the safest, Pagbelts are super-fast. Our Speed Charge 4000 units, for example, deliver a record-setting full charge in just 40 minutes for the 4AH model and 70 minutes for the 7AH.

And when you need location lighting, consider the ingenious Paglight: an illuminating experience from many viewpoints. An ultra-lightweight 12V system that's equally at home hand-held atop a camera or on a light stand. Activate its quiet, heavy-duty rocker switch and tilt it for bounce; control it with the four-leaf barndoor: filter with a dichroic filter in its holder—Paglight will supply ample, uniform illumination for up to 45 minutes with a 7AH belt. And, should the unforeseen happen, there's a spare 100W lamp and two fuses neatly tucked into its handle!

There's a lot more to know about the many breakthroughs built into this exciting portable power and lighting system. And we'll be glad to give you the details.

For more information contact your Comprehensive dealer or call us TOLL FREE at 800-526-0242. In New Jersey and Metro New York call 201-767-7990. Telex: 13-5139.

Comprehensive

VIDEO SUPPLY CORPORATION

148 Veterans Drive, Northvale, NJ 07647

In Canada: 751 Wall Street, Winnipeg, Man., R3G 2T6

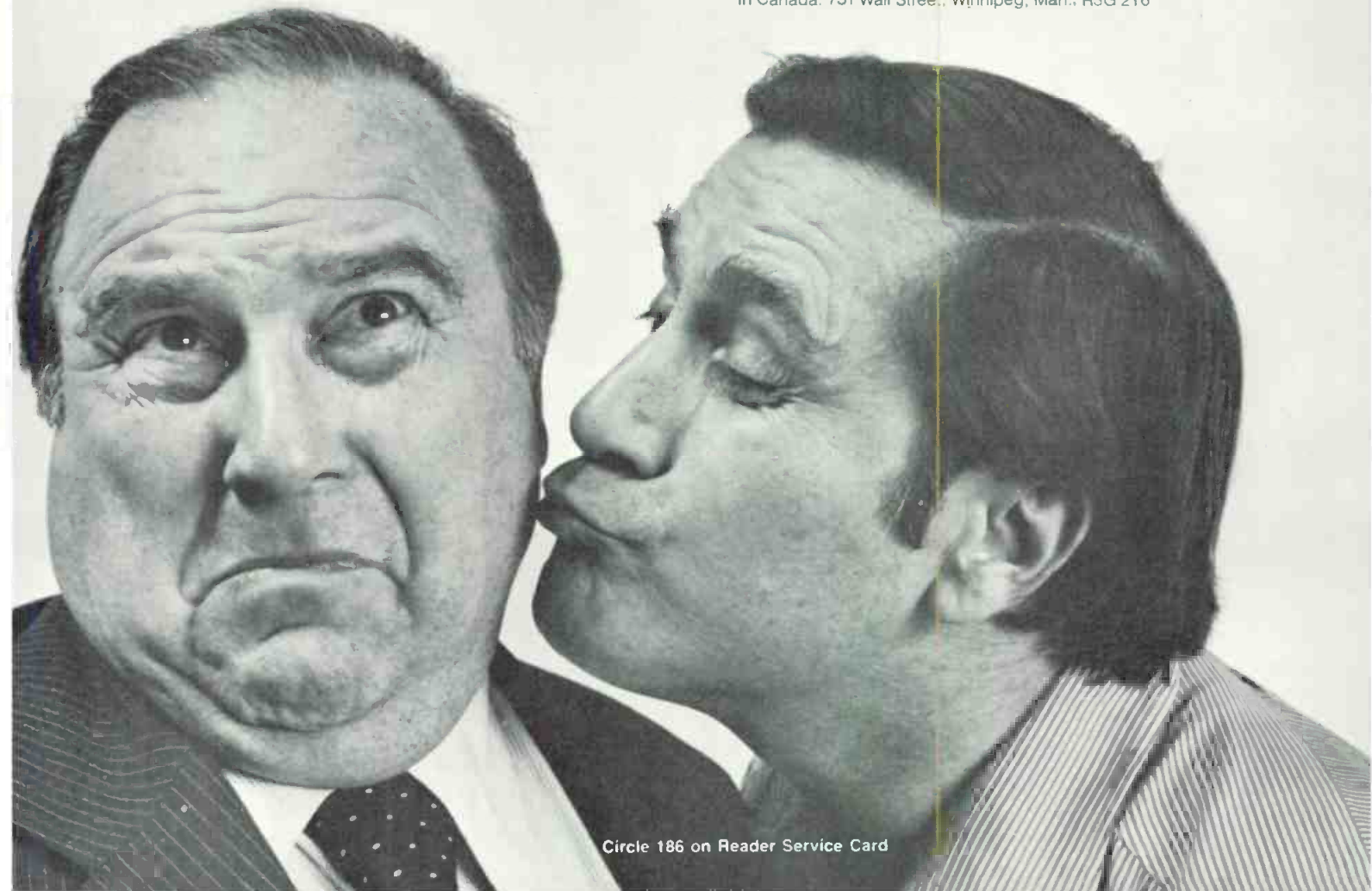

Circle 186 on Reader Service Card

Great Ideas

clipping off and adjust the 50K output level pot to provide about +15 dBm at the high side of the output attenuators. Adjust the 50K "amp null" pot for a minimum VU reading. Switch the clipping on and reduce input level so

2. News Bulletin Alarm

Craig S. Butler, Chief Engineer
WVOJ Radio, Jacksonville, Fla.

Problem: To build an inexpensive "bulletin" alarm circuit that would activate a light to notify operators to check a news wire teletype machine in another location. The circuit should contain a safeguard to prevent false triggering if "garble" is received.

Solution: Michael Phillips of WLNC offered a schematic for this problem in the October, 1978 *BM/E* that looked very interesting; I encountered some problems in working with it, however. First, the mechanical switch in the wire service printer caused logic "bounce" at the input of the 7490 and resulted in improper counting. Second, the outputs of the 7490 did not necessarily occur simultaneously because of internal ripple delays within the chip. Thus, the device would not consistently count correctly.

My circuit uses Phillips's basic design but is modified for consistent operation. First, the relay and the 7400 chip provide a "debounced" logic input from the wire service machine's bell contacts. This input goes to the 7490, wired as a basic "divide-by-two," and to the 74121, wired as a "one-shot." On the first bell, the output of the 74121 goes low and allows the 7490 to count. After two more bells, the Q1 output of the 7490 (pin 9) goes high and provides an input pulse to the 7445 (pin 14). When this occurs, the output on pin 3 of the 7445 goes low and fires the transistor, which in turn activates the SCR and the SSR. This configuration activates the alarm light after

about 0.5 percent harmonic distortion is measured at the output. Adjust the "clipping depth cal." pot for a "0" reading; repeat the procedure with the other channel. You may adjust the 50K output level pot to any desired level, but you must readjust the "amp null" pot. Adjust the modulation level of the transmitters with the output attenuators.

three bells.

To prevent false triggering, the 74121 normally sends a logic high to pins 2 and 3 of the 7490, which resets and holds its count at zero. When a bell is received by the teletype machine, the output of the 74121 (pin 1) goes low and allows the 7490 to count. The resistor and capacitor on pins 9, 10, and 11 of the 74121 keep the pulse low for about four to five seconds. If another bell is not received in that interval, the output returns high and resets the 7490 to zero.

This circuit is very easy to construct and very inexpensive. The regulated power supply, shown in the schematic, is also very reliable. We have had this device in service for some time and it has performed very well. Many thanks to Michael Phillips for his original design.

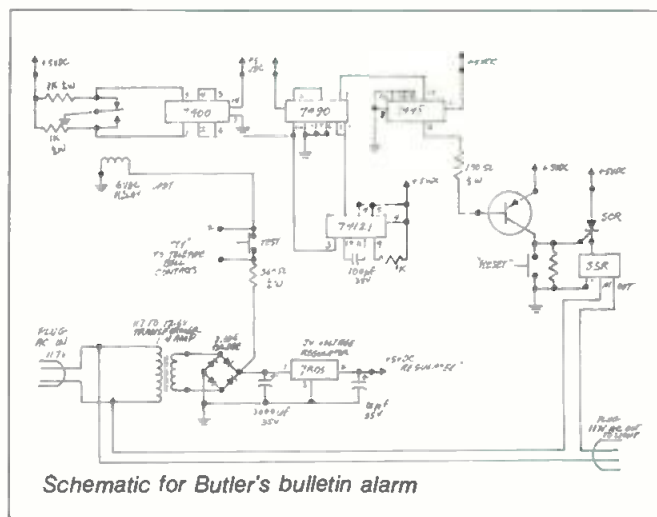

3. Stereo Line Amp

Tom Rose, Engineering Manager
KQFM, Portland, Oreg.

Problem: We've been doing several simulcasts with

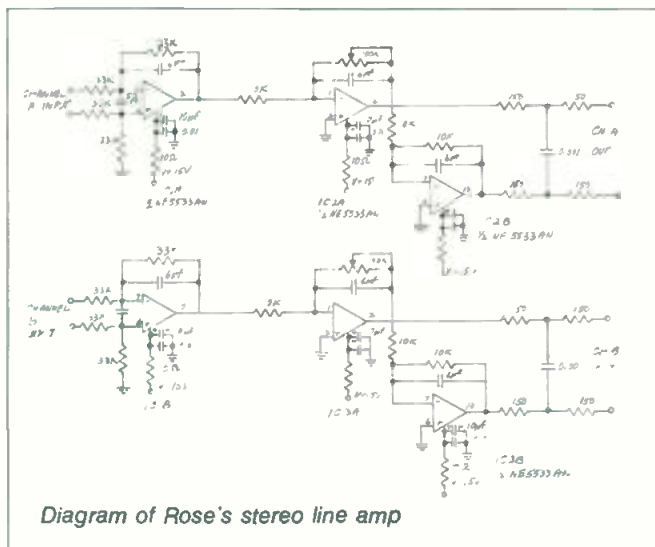

local TV outlets, including a cable company, in which a one-inch videotape production of a musical group is played back on television while the two stereo audio tracks are sent to us for broadcast on a pair of telco lines. Some of the TV outlets were not equipped to feed telco lines directly from their one-inch VTRs.

Solution: The stereo line amp shown was designed as a solution to the problem. It has a balanced bridging input, a balanced 600 ohm output, and is transformerless throughout. We used Signetics NE 5533N op-amps for simplicity and low noise; and since they are dual op-amps, the circuit is compact.

It will supply +22 dBm into a 600 ohm load before clipping with a slew rate close to 13 V/ μ s. Distortion at unity gain measures 0.044 percent at midband and noise is below 80 dB. IMD is 0.026 percent.

The input can be made 600 ohms instead of bridging by simply placing a 600 ohm resistor across the input terminals. RF proofing is accomplished by bypassing the power supply terminals on each op-amp and bypassing the input and output of the circuit.

An interesting feature of this device is that by adding duplicate output stages in parallel with those shown, a distribution amplifier can be created. **BM/E**

One Tube, 30KW FM Transmitter

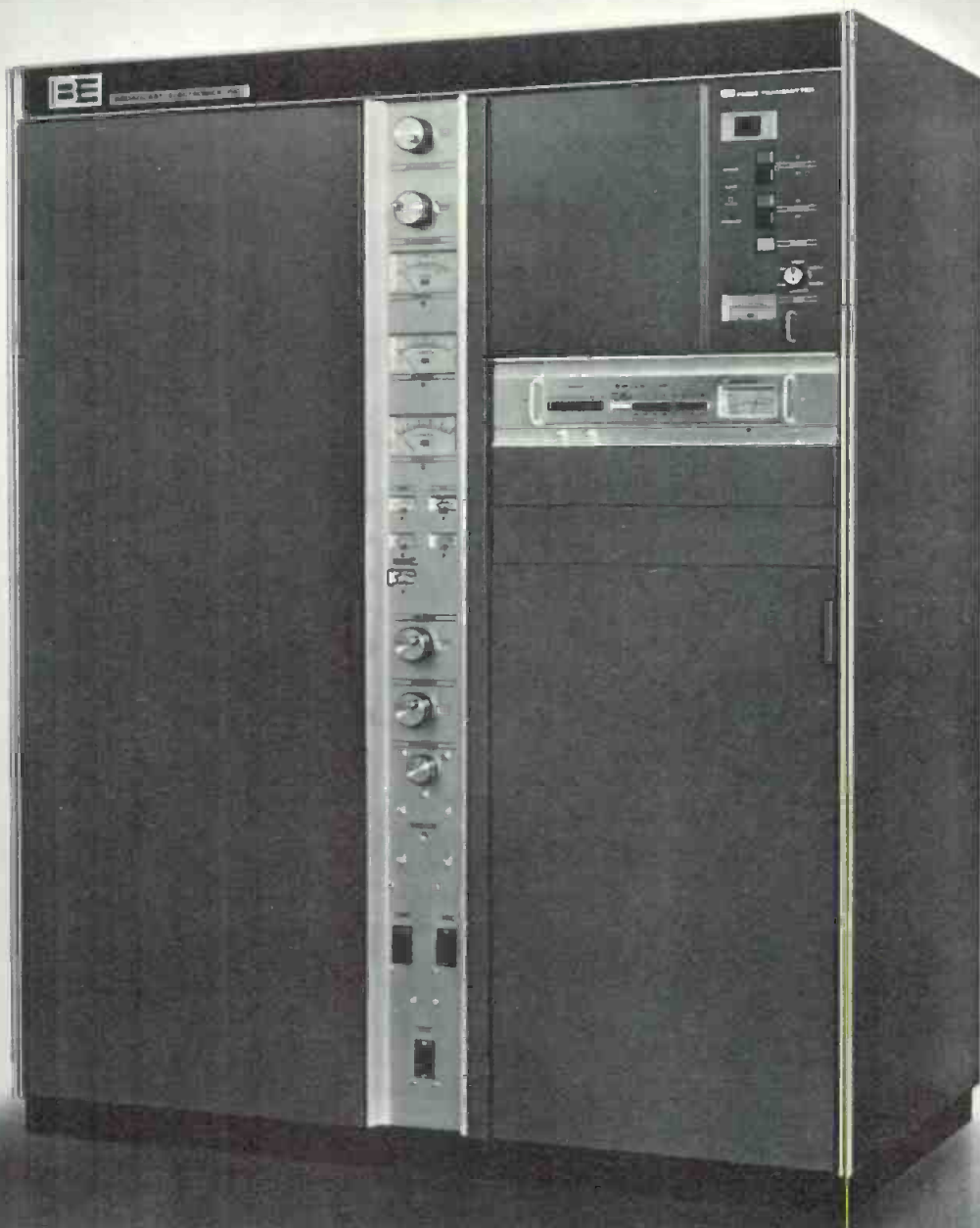

Broadcast Electronics' FM-30. The Most Advanced FM Transmitter Ever.

FIRST: World's most powerful one-tube FM Broadcast Transmitter.

FIRST:*Folded half-wave output cavity. No plate blocking capacitor or sliding contacts for greater reliability.

FIRST: Microprocessor Control. Provides 127 status indications, two BCD line outputs for ATS or remote control.

Then there's the totally new synthesized 30-watt FX-30 Exciter with extremely low IM distortion.

And a conservative 30KW output provided by the Eimac 8990/4CX20,000A tetrode driven by four solid state IPA modules with 25% drive power reserve.

With its elegant appearance and outstanding design, the new FM-30 is engineered for top reliability and the finest FM sound.

For more information about BE's exciting new FM Transmitters write or call Joe Engle today. 217-224-9600

a **FILMWAY** company



**BROADCAST
ELECTRONICS INC.**

4100 N. 24th STREET, P.O. BOX 3606, QUINCY, IL 62301, TELEX: 25-0142
Circle 187 on Reader Service Card

*Patent Pending

FOBA

TRIPOD



Price:
\$625.00

The Foba all-metal professional motion picture tripod features a Pro Jr. flat-top plate which accepts Pro Jr., O'Conner C and 50, Miller F and Pro heads. Foba's unique tubular adjustable legs allow the tripod to be used in both standard and baby positions. Legs can be adjusted individually or simultaneously. Tripod comes complete with triangle-type leg locks and elevating riser plate. Foba was selected for use in filming the 21st Olympiad.

alan gordon enterprises inc.
1430 Cahuenga Blvd., Hollywood, CA 90028
Telephone: (213) 466-3561 • (213) 965-5500
TWX: 910-321-4826 • Cable: GORBENT

Circle 188 on Reader Service Card

24-HR. PROFESSIONAL SERVICE FOR COLLINS & CONTINENTAL AM & FM TRANSMITTERS

Continental Electronics offers parts and engineering service for all Collins AM & FM transmitters.

Whenever you want parts or service for your Collins or Continental equipment, phone our service numbers day or night,

(214) 327-4532 parts
(214) 327-4533 service

Continental Electronics Mfg. Co.
Box 270879, Dallas, Texas 75227
Phone (214) 381-7161
1 kW thru 50 kW AM & FM transmitters and related equipment.

Continental Electronics

"A New Strength in Radio Broadcasting Equipment"

Circle 189 on Reader Service Card

BROADCAST EQUIPMENT

This month's Broadcast Equipment column highlights products introduced at the recent International Broadcasting Convention in Brighton, England. Indicated by the IBC logo, they include a digital still store, a color corrector, a subtitling system, and camera support equipment.

Fluid Head 250



The Studio 7 heavy-duty fluid head will accept up to 70 pounds of weight and is designed for use with the manufacturer's existing range of tripods and accessories. It features seven prefixable fluid positions on both pan and tilt.



Central balance is obtained by the built-in center of gravity balance system. The top plate assembly incorporates a quick-release plate; the mounting plate is standard Arriflex, but a Vinten and Mitchell adapter will be available shortly. Facilities for twin pan bars allow the head to be used with electronic cameras as well as film cameras. SACHTLER.

Remote SCA Generator 251

The MSG-95 remote SCA generator is designed for use with most exciters or STL links and is an ideal companion unit to the maker's MSP-95 audio composite processing unit and stereo generator. It is equipped with two input terminals: an ac-coupled input for general SCA programming needs and a dc-coupled unit for SCA broadcasters programming slow-scan TV data. A standard low-pass filter is included to

provide the necessary bandwidth protection for stations operating one or two SCAs or stereo programming. Pre-emphasis is selectable at 150, 75, or 50 microseconds, or flat response. The muting delay can be adjusted anywhere from half a second to 20 seconds. It is triggered by a drop in audio level, with audio threshold adjustable from 0 to -30 dBm. Color-keyed status indicators are positioned adjacent to the ON, AUTOMATIC, and OFF pushbutton selector switches. HARRIS CORP.

Digital Still Store System 252



The DLS 6000 Digital Library System is a still storage device featuring simple generation of stills, low running and maintenance costs, and easy management of a central library. Input video is immediately converted into digital format and stored on a Winchester-type disc drive, eliminating signal degradation. The number of discs — each holding 280 pictures — is unlimited, giving very high storage capacity. The device is small enough for use in mobile vans as well as in the studio. Three outputs include one preview and two program; preview includes a BROWSE facility that enables the user to look through the contents of a disc by displaying 25 images simultaneously. Since the unit can handle asynchronous information, stills can be captured from incoming ENG material. It can also key in stored graphics over displayed images. Production effects include compression, enlargement, repositioning, adding borders and background. MCI/QUANTEL.

Monitor Loudspeaker 253

Designed for use in custom studio monitors or other applications requiring high sensitivity and great power-



**For more information
circle bold face numbers
on reader service card.**

An Obscene Phone Call? Vibrating Earmuffs? Fingernails On A Blackboard? What Is Aural Excitement?



APHEX™

The Aphex Aural Exciter™ gives you sonic realism obtainable by no other means. Producers of over 4000 albums have relied on this unique effect to give their recordings true spatiality and detail. Broadcasters around the world are now turning to the Aphex™ to give an added dimension of clarity and presence without making the sound unnatural or inducing listener fatigue. In-line or in your production room, give yourself and your listeners the opportunity to experience the answer to "What is Aural Excitement?" Aphex™.

Circle 190 on Reader Service Card



Aphex Systems, Ltd.
7801 Melrose Avenue
Los Angeles, CA 90046
(213) 655-1411
TWX: 910-321-5762

Broadcast Equipment

handling capacity as well as low distortion, Model 2245H is an 18-inch low frequency loudspeaker featuring the maker's recently developed Symmetrical Field Geometry (SFG) flux-stabilized magnetic structures, new high-temperature adhesives, and composite voice coil formers. It incorporates a new diecast aluminum frame and integrally stiffened cone with foam surround. The unit's motor assembly is equipped with a long, one-inch deep

voice coil for maximum excursion linearity. Frequency range is 20 Hz to 2 kHz; power capacity is 600 W; sensitivity is 95 dB SPL (1 W, 1 m). JBL.

Color Correction System 254



Vidigrade is Rank Cintel's new system for high-quality, precise color correction of composite video signals. Typical applications include ENG (where scenes can be color balanced during editing), matching film and elec-

tronic camera inserts, correcting badly color-matched videotapes, and EFP (where several picture sources can be accurately matched). The totally self-contained, portable unit requires a standard, composite video signal as its input and produces a color-corrected signal at its five outputs. Color control is via three joysticks, which control master and differential LIFT, GAMMA, and GAIN functions. Housed in a standard control panel, these joysticks can be remoted from the main electronics, which are either 19-inch rack-mounted or separate. STRAND CENTURY.

Videotape Animation 255

The Anivid system for direct frame-by-frame animation on videotape produces a broadcast-quality finished product directly on tape. It accepts any form of artwork — manually or computer generated, flat or three-dimensional — and implements all the techniques of film animation with higher speed, lower cost, and higher quality final image, according to the manufacturer. The system consists of a three-tube color video camera mounted on a full-featured animation stand and an animation controller with interface to

COLOR PRODUCTION SWITCHERS

PRICED
AS LOW AS
\$995

MODEL 1150B

MODEL 1127

MODEL 1107 AC/DC

FOR MORE DETAILS
CALL OR WRITE

105 EAST 69th AVENUE
VANCOUVER, B.C.
CANADA V5X 2W9
PHONE (604) 327-9446
TELEX 04-508605

DISCOUNT INDUSTRIES Inc.

Circle 191 on Reader Service Card



an unmodified customer-supplied one-inch or 3/4-inch VTR. It operates by performing a succession of very accurate one-frame edits on videotape moving through the VTR at normal speed. Artwork may be illuminated from above or below; each individual piece of artwork may be animated onto tape in "exposure" cycles of one or more frames per cycle (up to 999,999 frames). Exposure cycles may also be performed automatically and may be previewed before they are performed. ANIMATION VIDEO, div. CONVERGENCE CORP.

VIDEO & PULSE DELAY LINES

- PC MOUNT
- BOXED
- RACK MOUNT
- DELAY CARDS

- TOP QUALITY
- LARGEST STOCK
- BEST DELIVERY
- LOWEST PRICE

CONTACT THE DELAY LINE COMPANY

broadcast video systems Ltd.

1050 McNicoll Ave.
Toronto, Ont. M1W 2L8
(416) 497-1020

1438 N. Gower
Hollywood CA. 90028
(213) 460-2949

Circle 192 on Reader Service Card

**For more information
circle bold face numbers
on reader service card.**



The Quantafont QST subtitling system combines a full-function, high-performance teleproduction studio titler with an expanded software and time code interface package to provide flexible automatic or manual electronic subtitling. It features the Quantafont Q-7A teleproduction graphic titler, switch-selectable for complete subtitling program or teleproduction studio titling; dual flexible disc memory storage and playback, providing an unlimited number of automatic or manual three-row, 32-character subtitles; and a subtitling software program that interfaces directly with audio or TTL level EBU/SMPTE time codes. NEXT, CURRENT, and PRIOR control rows are provided simultaneously by the TIMING and EXECUTE modes, making relevant, sequential timing relationships available on a title-by-title basis. Full-function keyboard allows composition of individual subtitles, providing a full-resolution edit output with all character enhancement, titling font, and exact raster position. SYSTEM CONCEPTS.

AC Power Source

257

Model 161T Invertron® solid state ac power source is now available in an open-frame version. The unit provides either line independent or line synchronous low distortion ac power for applications such as precision video or audio recording equipment. Driven by an external 5 V RMS signal, the power source may be used to precisely control the speed of synchronous drive motors. With the addition of a precision built-in oscillator, motor speed can be made independent of input line frequency fluctuations. CALIFORNIA INSTRUMENTS.

Compressor/Limiter

258

The Gemini Easy-Rider stereo/dual mono compressor/limiter, for broadcast and recording applications, features infinitely variable compression slope ranging from a very soft (1.5:1) to limit (20:1) ratio with convenient switched out mode (1:1) as well as system bypass switch. Optimum attack time is calculated by a control that responds to program characteristics. Slower settings can be used safely since the unit will adjust its attack automati-



cally to handle unforeseen peaks. Dynamic attack change, relative to level, can range from 500 μ s to 5 ms. Release time can also be programmed automatically or set between 15 ms and 4 s for specific signal shaping. The unit offers 33 dB gain with 25 dB control range from onset of limiting to maximum clip level of +18 dBm. It can be used as two mono channels with crosstalk better than -77 dB. S/N is -82 dB. It takes up 1 3/4 inches of 19-inch rack space and has a 230/115 V, 50/60 Hz power supply. \$875. AUDIO & DESIGN RECORDING.

UHF Tetrodes

259



This new series of ultra-linear high-gain UHF TV tetrodes comprises the TH 393, TH 382, and TH 582, with video carrier ratings of 5, 10, and 20 kW, respectively. They feature low output capacitance and can operate, in their matched coaxial cavity circuits, all the way up to 860 MHz in the most favorable 1/4-wavelength mode with no spurious oscillations. They have a minimum power gain of 16 dB when used

Unattended Transmitter Monitor, Alarm & Control

Model 5003

Installed at remote transmitter locations. Direct connection to public telephone network, leased lines, two-way radio or microwave network. Feeds data to Model 5004.

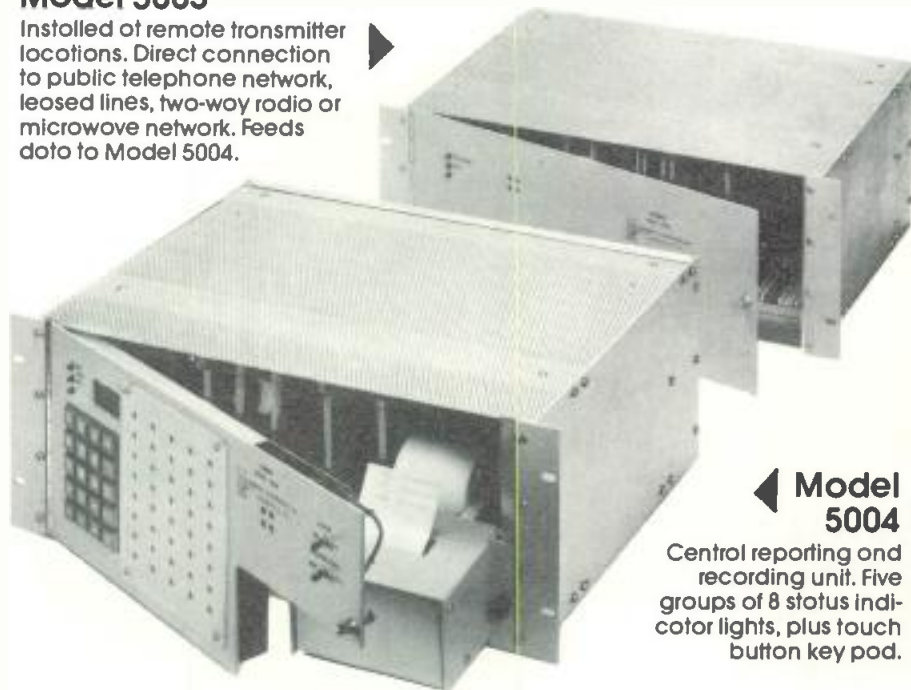

Model 5004

Central reporting and recording unit. Five groups of 8 status indicator lights, plus touch button key pod.

Remote Supervisory Model 5003

Capable of monitoring and controlling up to 5 transmitters at one remote site plus building status. It connects directly to dial-up public telephone, radio, or microwave. Stand by battery power supply is standard.

Central Model 5004

Displays the status of (8 to 48) remote contacts and has the hard copy data logger to provide the permanent record of time of day, date and status.

These two units can be equipped to provide building security with recordings to notify local security forces.

Send for full color, 4-page brochure.



MONROE ELECTRONICS, INC.

212 Housel Avenue Lyndonville NY 14098
Phone: (716) 765-2254

Circle 193 on Reader Service Card

The Gordon Headroom Meter:

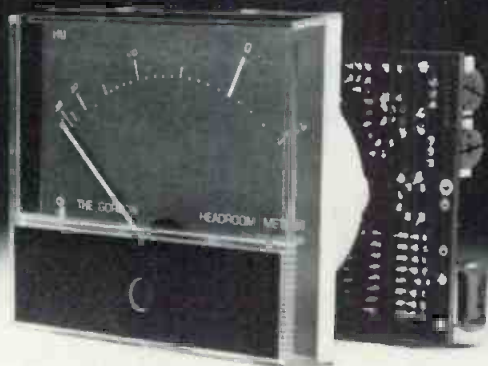

a better idea in program monitoring.

We've combined the best aspects of the traditional VU meter and the precision of the European Programme meter. The result is a meter that meets the UK/EBU standard for

response to program peaks while maintaining a more conventional and artistically desirable "syllabic" response to music and speech.

Get the complete package for \$122.00, or our VU-conversion option for \$69.00. Quantity discounts are available. For further information, contact:

Inovonics, Inc.
503-B Vandell Way
Campbell, CA 95008
Telephone
(408) 374-8300

Send for copy of AES preprint.



Circle 194 on Reader Service Card

ONE REASON WE'RE HOT.

VIDEO/FILM STYLE

RCA and Ikegami single camera packages with 1 inch portable recorder
RCA TKP-45 studio packages
Multiple camera capability

Contact Larry Kingen 415/777-5777

One Pass Inc.
The San Francisco Production Center
900 Third Street, San Francisco, California 94107

Circle 195 on Reader Service Card

Broadcast Equipment

for combined video and sound-carrier transmitters and translators. When operating in matched cavity circuits (models TH 18365, TH 18382, and TH 18582, respectively), their instantaneous electronic bandwidths exceed 10 MHz and the third-order intermodulation ratio is 52 dB or better (three-tone test) for the TH 393 and 48 dB or better for the other two. THOMSON-CSF.

Open-Reel Audio Deck

260

RS-10A02 two-track stereo open-reel audio tape deck features an "isolated loop" transport that maintains stable tape tension, greatly reduces modulation noise, wow, and flutter, and offers highly accurate tape speed. Fluctuation is 0.05 percent or less; deviation is ± 0.10 percent or less. The Technics SX head gives ultra-low distortion,

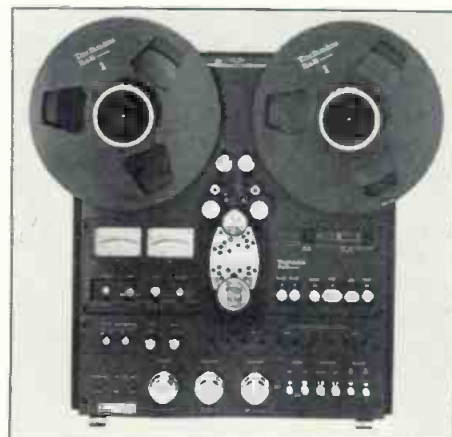

according to the manufacturer. The 34 mm diameter capstan is driven by a low-speed quartz PLL direct drive motor. Wow and flutter is rated as 0.018 percent WRMS. Other features include a quartz-controlled stroboscope, pitch control that permits up to ± 6 percent tape speed variation during both recording and playback, electronic tape tension control, and aluminum diecast chassis. Editing facilities include a unique edit dial for precise location of the editing on the reversing roller and a CUE/EDIT switch that allows audio playback during hand-controlled reel movement. PANASONIC.

ENG Shoulder Mount

261



Flat-base ENG cameras may be comfortably supported on the shoulder by means of the type 204 shoulder mount. Adjustable to fit various body types, the mount is trimmed in durable and "black simulated leather" over layers of different density foam and cotton wadding for a firm and comfortable

feel. A quickly adjustable lockable forward flap panel gives additional support and takes out reaction loads when leaning forward. The panel can be folded forward when unlocked, permitting the mount to stand firmly on the ground with camera attached. The adjustable under-arm support strap has a quick-release snap hook-type fastening at the front. Camera attachment is via the maker's "Mini-Matic Wedge." Weight is five pounds, eight ounces. W. VINTEN LTD.

Professional Audio Tape 262

IBC 80 Type 675 is a new high-output, low noise professional recording tape designed for music mastering, broadcasting, and other critical multi-track applications. It features a new low print-through oxide formulation that gives an S/N ratio of 74.5 dB and a print-through figure of -60 dB. Available in quarter-inch, half-inch, one-inch, and two-inch widths, the polyester-based tape has a conductive matte black backing that combats problems caused by static and assists rapid winding. RACAL-ZONAL.

Portable Time Code Generator 263

Model PTC-100 portable time code generator/reader is a rugged, reliable, compact unit designed for TV and film EFP requirements. The unit identifies color field sequence in time code and generates user bits. It meets film standards for 24, 25, and 30 fps. An integral jam sync reader permits slaving several



units together. New user bits can be preset and entered without disturbing the time counter, which may be operated remotely. Thumbwheels preset time counter or load bits. There are no multi-function controls. The unit operates for five days with four AA cells (Ni-cad batteries and charger are optional); it can also be plugged into an external 6-12 V dc source. \$2800. SKO-TEL.

For more information circle bold face numbers on reader service card.

Ursa Major Is a Sound Improvement

Our versatile new digital reverb unit is the most useful sound processor a broadcaster can buy today. The SPACE STATION™ can give added presence and body to a live announcer's voice, enhance music and speech for more sophisticated in-house commercials, simulate an endless variety of acoustic spaces, and generate unusual special effects. The SPACE STATION can even create a spacious mono-compatible "stereo" version of the source that is especially effective to anyone listening in the limited confines of a car.

If you're curious about how the SPACE STATION can improve your station's sound, write for our special broadcast demonstration cassette (\$2.00 each). For reverberation quality and variety, for special effects features, and for price, the SPACE STATION is the best sound improvement you can make.



Demonstration cassettes for broadcast and recording applications are available for \$2.00 each

URSA MAJOR, Inc.
 Box 18 Belmont MA 02178 • Telephone (617) 499-0303
 Telex 921405 URSAMAJOR BELM

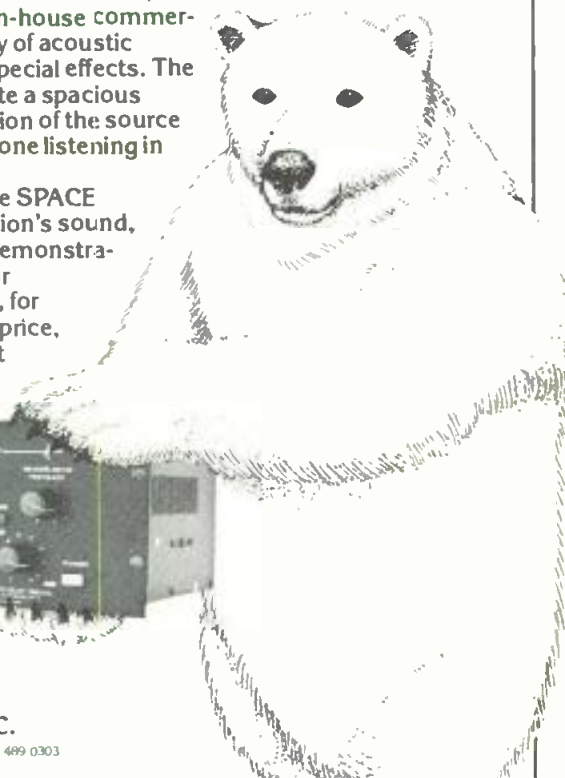

Circle 196 on Reader Service Card

Field Service Engineers

The Grass Valley Group, Inc. a leading manufacturer of television broadcast equipment, is looking for people who want challenging professional positions PLUS the added attraction of working in a small town nestled in the Sierra foothills.

These challenging positions combine chances for U.S. travel plus marketing and engineering career opportunities. Individuals with experience designing and/or maintaining television broadcast systems are required to provide after-sales support for our wide variety of complex systems.

Interested and qualified candidates are invited to send a resume in confidence to Sylvia Smith, The Grass Valley Group, Inc., P.O. Box 1114, Grass Valley, CA 95945. An Equal Opportunity Employer M/F/H.

The Grass Valley Group
 A Tektronix Company

"Frezzi-Lite"™ Portable Camera Lights

Choice of 100w, 150w, 250w, 350w.
 Removable dichroic filter.
 for video/TV & film/cine



Power "Frezzi-Lites" with "Frezzi" Battery Packs.

Hand-held. Lightstand or film and video camera mounting.

Made in U.S.A.

For information IN.J. 201 427 1160 IN.Y.C. 212 594 2294

Frezzolini Electronics Inc.
 7 Valley St. Roseton, N.J. 07506 USA

Circle 198 on Reader Service Card

Advertisers Index

| | | | |
|---|----------|--------------------------------------|----------|
| Acrodyne | 22 | U.S. JVC Corp. | 73 |
| ADM Technology, Inc. | C2, 9 | Lemo USA | 56 |
| Aiden Electronics | 79 | Lenco Inc. | 100 |
| American Data Corp. | 32 | 3M/Magnetic Tape Div. | 11,97 |
| Ampex MTD | 46 | 3M/Minicom-Video Products | 58-59 |
| Ampex AVSD | 81 | Maxell Corp. of America | 106 |
| Anvill Cases Inc. | 29 | McCurdy Radio Ind. | C3 |
| Aphex | 129 | MCI/Quantel (Micro Consultants Inc.) | 68 |
| Arvin/Concepts | 75 | MCI, Inc. | 51-54 |
| Arvin Echo | 77 | Microtime Inc. | 40 |
| Asaca Corp. of America | 13 | Microwave Associates Communications | 17 |
| Audio Techniques | 102 | L. Matthew Miller | 96 |
| Auditronics Inc. | 24 | Monroe Electronics-O'Brien | 131 |
| Belar Electronics Lab. Inc. | 134 | Neal Ferrograph | 26 |
| BGW Systems | 111 | NEC America, Inc. | 119 |
| Broadcast Controls | 118 | Rupert Neve Inc. | 15 |
| Broadcast Electronics Inc. | 127 | One Pass Inc. | 132 |
| Broadcast Video Systems | 130 | Orban Associates Inc. | 28 |
| Camera Mart, Inc. | 36 | Otari Corp. | 113 |
| Canon USA Inc. | 62 | Panasonic Matsushita | 30-31,37 |
| Centro Corp. | 65 | Philips Broadcast Equipment Corp. | 84 |
| Cazar International Ltd. | 116 | Potomac Instruments | 108 |
| Chronrol/Lindberg Enterprises | 118 | Ramko Research | 82-83 |
| Chyron Corp. | 25 | RCA Broadcast System | 60 |
| Cine 60 Inc. | 110 | Saki Magnetics | 108 |
| Cinema Products Corp. | 43 | Sharp Electronics | 66-67 |
| CMX/Orrox | 38-39 | Shintron | 14,16 |
| Comprehensive Video Supply Corp. | 125 | Sound Dynamics | 80 |
| Comrex | 19 | Stanton Magnetics Inc. | 102 |
| Continental Electronics Mfg. Co. | 96,128 | System Concepts | 10 |
| Convergence Corp. | 94 | TEAC Corp. of America | 114 |
| CSI Electronics Inc. | 117 | Technology Service Corp. | 91 |
| Digital Video Systems | 103 | Toshiba | 3 |
| EEV Inc. | 35 | Trompeter Electronics, Inc. | 134 |
| Electro-Voice | 104 | Ultra Audio Products | 134 |
| Excalibur Industries | 122 | Ursa Major | 133 |
| Fernseh Inc. | 44-45 | Varian, Elmac Div. | 92 |
| Frezzolini Electronics Inc. | 133 | Video Aids Corp. of Colorado | 124 |
| Fujinon Optical Inc. | 20-21 | Videomedia, Inc. | 34 |
| Alan Gordon Enterprises Inc. | 128 | Viscount Industries Ltd. | 130 |
| Grass Valley Group Inc. | 7,18,133 | Ward-Beck Systems Ltd. | C4 |
| Gray Engineering Labs | 56 | Weathermation Inc. | 88 |
| David Green Broadcast Consultants Corp. | 110 | Winsted Corp. | 116 |
| Harris Corp. | 12,86 | Wold Communications | 120 |
| Harris/Farion | 48 | ZRC Chemical Products Co. | 112 |
| Hitachi Denshi American Ltd. | 4-5 | | |
| Hughes Helicopters | 27 | | |
| Ikegami Electronics USA Inc. | 98 | | |
| Inovonics Inc. | 132 | | |
| International Tapetronics Corp. | 109 | | |

SALES OFFICES

BME

Broadcast Management/Engineering

295 Madison Ave.
New York, New York 10017
Telex: 64-4001

Eastern & Midwestern States

295 Madison Avenue
New York, New York 10017
212-685-5320
James C. Maywalt
Denis J. O'Malley

Western States

353 Sacramento Street
Suite 600
San Francisco, CA 94111
415-421-7330
William J. Healey
Roger Wadley

3420 Ocean Park Blvd., Suite 3020
Santa Monica, CA 90405
213-450-7181
Bob Hubbard

United Kingdom/Europe

Chilberton House
Doods Road
Reigate, Surrey, England
Telephone: Reigate 43521
Robert N. Burn
Bronwyn Holmes
Derek Hopkins

Japan/Far East

Eiraku Building
1-13-9, Ginza,
Chuo-Ku, Tokyo 104 Japan
03 (562) 4781
S. Yasui
K. Yamamoto

When accuracy Counts...Count on Belar for AM/FM/TV MONITORS



BELAR CALL ARNO MEYER (215) 687-5550
ELECTRONICS LABORATORY, INC.
LANCASTER AVENUE AT DORSET. DEVON. PA. 19333 • BOX 826 • (215) 687-5550

Circle 199 on Reader Service Card

The Rackmount Monitor You've Always Wanted

3 clean audio watts from a -20dbm line • only 2 rack-units (3.5") height • transformer input • headphone disconnects 'speaker • input front & rear • smooth response



AM3 shown patched to monitor the outputs of the incredible MR5x5 audio D.A. offering 5 5-output transformer-coupled line amplifiers (5x5) in but 1 rack-unit space.

Ultra Audio Products
A DIVISION OF AUDIO INTERNATIONAL, INC.

P.O. BOX 921 • BEVERLY HILLS
CA 90213 • 213/276-2726

Circle 200 on Reader Service Card

ARMORED CAMERA CABLES



Typical armored camera cable consists of teflon jacketed coax cables and control conductors enclosed within a spiral-wound 302 stainless steel armor sheath.

Trompeter cable assemblies are designed for use under abusive conditions. They are kink proof, crush, pull and abrasion resistant.

Also available in coax and audio configurations.

FREE DATA SHEET

Trompeter Electronics, Inc.
8936 Comanche Avenue
Chatsworth, Calif. 91311
(213) 882-1020

Circle 201 on Reader Service Card



SS8800

A new console concept for the 80's

The SS8800, a compact, fully modular, desk mounting 8 mixer stereo console providing full broadcast facilities in a functionally styled package utilizing professional quality circuitry of proven reliability is now available for the unusually attractive price of \$9,500.00.

The engineering expertise of McCurdy Radio, now into their 4th decade of providing audio equipment to the broadcast industry, ensures that the SS8800 incorporates all the features expected in a modern console and is fully systems compatible.

The SS8800, also obtainable in 16 mixer form, is available with a full range of prewired options and as an integral part of complete packaged systems custom tailored to your requirements.



MCCURDY RADIO INDUSTRIES • TORONTO (416) 751-6262 • CHICAGO (312) 640-7077

Circle 203 on Reader Service Card

Ward-Beck NY!

Morning and evening,
major personalities and
events cover the nation
from ABC Television in
New York.

"Good Morning America"
and "20/20 News Magazine"
now originate from
ABC's new Studio TV2
featuring this highly
sophisticated Ward-Beck
console system.

Ward-Beck loves New York!



First by Design.

Ward-Beck Systems Ltd., 841 Progress Avenue, Scarborough, Ontario, Canada M1H 2X4.
Tel:(416)438-6550.

Ward-Beck Systems Inc., 6900 East Camelback Road, Suite 1010, Scottsdale, Arizona 85251.